

Zebra *XiII*-Series

User's Guide

Customer order # 48460L
Manufacturer part # 48460LB Rev. 2

Proprietary Statement

This manual contains proprietary information of Zebra Technologies Corporation. It is intended solely for the information and use of parties operating and maintaining the equipment described herein. Such proprietary information may not be used, reproduced, or disclosed to any other parties for any other purpose without the expressed written permission of Zebra Technologies Corporation.

Product Improvements

Continuous improvement of products is a policy of Zebra Technologies Corporation. All specifications and signs are subject to change without notice.

FCC Compliance Statement

NOTE: This equipment has been tested and found to comply with the limits for a Class A digital Device, pursuant to Part 15 of the FCC Rules. These limits are designed to provide reasonable protection against harmful interference when the equipment is operated in a commercial environment. This equipment generates, uses and can radiate radio frequency energy and, if not installed and used in accordance with the instructions manual, may cause harmful interference to radio communications. Operation of this equipment in a residential area is likely to cause harmful interference in which case the user will be required to correct the interference at his own expense.

In order to insure compliance, this printer must be used with a Shielded Power Cord and Shielded Communication Cables.

"The user is cautioned that any changes or modifications not expressly approved by Zebra Technologies Corporation could void the user's authority to operate the equipment."

Canadian DOC Compliance Statement

This digital apparatus does not exceed the Class A limits for radio noise emissions from digital apparatus as set out in the radio interference regulations of the Canadian Department of Communications.

CE Compliance

If the accompanying printer displays the CE mark, it also meets EMC directive 89/336/EEC, with amendments effective at the time of manufacture.

Liability Disclaimer

Zebra Technologies Corporation takes steps to assure that its published Engineering Specifications and Manuals are correct; however, errors do occur. Zebra Technologies Corporation reserves the right to correct any such errors and disclaims liability resulting therefrom.

No Liability for Consequential Damage

In no event shall Zebra Technologies Corporation or anyone else involved in the creation, production, or delivery of the accompanying product (including hardware and software) be liable for any damages whatsoever (including, without limitation, damages for loss of business profits, business interruption, loss of business information, or other pecuniary loss) arising out of the use of or the results of use of or inability to use such product, even if Zebra Technologies Corporation has been advised of the possibility of such damages. Because some states do not allow the exclusion or limitation of liability for consequential or incidental damages, the above limitation may not apply to you.

Copyrights

This copyrighted manual and the label printer described herein are owned by Zebra Technologies Corporation. All rights are reserved. Unauthorized reproduction of this manual or the software in the label printer may result in imprisonment of up to one year and fines of up to \$10,000 (17 U.S.C.506). Copyright violators may be subject to civil liability.

All trademarks are the property of their respective owners. Centronics is a registered trademark of Genicom Corporation. Compugraphic is a registered trademark and CG Triumvirate, CG Triumvirate Condensed, CG Palacio, and CG Times are all Trademarks of AGFA Corporation. Futura is a trademark of Fundicion Tipografica Neufville, S.A. TrueType is a registered trademark of Apple Computer, Inc. Univers is a registered trademark of Linotype AG and/or its subsidiaries. IBM is a registered trademark and Windows is a trademark of IBM Corporation. BAR-ONE, SCAN-ONE, Stripe, TRACK-ONE, WEDGE-ONE, Zebra, ZPL, and ZPL II are registered trademarks and TotalCare is a trademark of Zebra Technologies Corporation.

Copyright Zebra Technologies Corporation. All rights reserved.

Warranty Information

1. Printer Warranty

ZEBRA printers, excluding thermal printheads which are warranted separately below, are warranted against defects in material or workmanship for six (6) months from the date of original shipment by ZEBRA Technologies Corporation. This warranty does not cover normal wear and tear and shall be null and void if the equipment is modified, improperly installed or used, damaged by accident or neglect, or in the event any parts are improperly installed or replaced by the user.

Since printhead wear is part of normal operations, the original printhead and replacement printheads are covered by a limited warranty of six (6) months from the date of original shipment by ZEBRA Technologies. To qualify for this warranty, the printer must be returned to the factory or other authorized service center. Although the user is not required to purchase ZEBRA brand supplies (media and/or ribbons), to the extent it is determined that the use of other supplies (media and/or ribbons) shall have caused any defect in the thermal printhead for which a warranty claim is made, the user shall be responsible for ZEBRA Technologies' customary charges for labor and materials to repair such defect. To the extent that it is determined that failure to follow the preventive maintenance schedule and procedures listed in the User's Guide shall have caused any defect in the thermal printhead for which a warranty claim is made, this limited warranty shall be void.

ZEBRA TECHNOLOGIES' SOLE OBLIGATION UNDER THIS WARRANTY SHALL BE TO FURNISH PARTS AND LABOR FOR THE REPAIR OR REPLACEMENT OF PRODUCTS FOUND TO BE DEFECTIVE IN MATERIAL OR WORKMANSHIP DURING THE WARRANTY PERIOD.

As a condition of this warranty, the user must: (a) obtain a ZEBRA Return Authorization for the printer, or subassembly(s); (b) ship the printer or subassembly(s), transportation prepaid to the authorized service location; and (c) include with the Product or subassembly(s) a written description of the claimed defect. Unless ZEBRA Technologies authorizes return of the entire Product, the user shall return only the subassembly(s). Products returned shall be packaged in the original packing and shipping container or comparable container. In the event equipment is not so packaged or if shipping damage is evident, it will not be accepted for service under warranty. Surface transportation charges for the return of the printer to the customer shall be paid by ZEBRA Technologies within the 48 contiguous states and the District of Columbia. Customer shall pay shipping costs, customs clearance, and other related charges outside the designated area. If ZEBRA Technologies determines that the Product returned to it for warranty service or replacement is not defective as herein defined, BUYER shall pay all costs of handling and transportation.

2. Supplies Warranty

ZEBRA supplies are warranted to be free from defects in materials or workmanship for a period of either the stated material shelf life or 6 months from date of shipment, whichever occurs first, provided that the BUYER has complied with ZEBRA Technologies' guidelines on storage, handling, and usage of the labeling supplies in ZEBRA printers. ZEBRA Technologies does not warrant the performance of ZEBRA labeling supplies on non-ZEBRA printers.

Any supplies product shown to the satisfaction of ZEBRA Technologies, within the time provided, to be so defective shall be replaced without charge, or ZEBRA Technologies may issue a credit in such an amount as it deems reasonable.

3. Warranty Exclusions and Conditions

The above warranties are in lieu of all other warranties, expressed or implied, oral or written, statutory or otherwise, including any implied warranty of merchant-ability or fitness for a particular purpose.

ZEBRA Technologies shall not be responsible for the specific application to which any Products are applied, including but not limited to compatibility with other equipment.

All statements, technical information and recommendations relating to ZEBRA Products are based upon tests believed to be reliable but do not constitute a guarantee or warranty.

ZEBRA TECHNOLOGIES SHALL NOT, UNDER ANY CIRCUMSTANCES WHATSOEVER, BE LIABLE TO BUYER OR ANY OTHER PARTY FOR LOST PROFITS, DIMINUTION OF GOOD WILL OR ANY OTHER SPECIAL OR CONSEQUENTIAL DAMAGES WHATSOEVER WITH RESPECT TO ANY CLAIM HEREUNDER. IN ADDITION, ZEBRA TECHNOLOGIES' LIABILITY FOR WARRANTY CLAIMS SHALL NOT, IN ANY EVENT, EXCEED THE INVOICE PRICE OF THE PRODUCT CLAIMED DEFECTIVE, NOR SHALL ZEBRA TECHNOLOGIES BE LIABLE FOR DELAYS IN REPLACEMENT OR REPAIR OF PRODUCTS.

No salesperson, representative or agent of ZEBRA Technologies is authorized to make any guarantee, warranty, or representation in addition to the foregoing warranty.

NO WAIVER, ALTERATION, ADDITION, OR MODIFICATION OF THE FOREGOING WARRANTIES SHALL BE VALID UNLESS MADE IN WRITING AND SIGNED BY AN EXECUTIVE OFFICER OF ZEBRA TECHNOLOGIES.

Zebra Software License Agreement

The enclosed software and documentation are protected by the United States copyright law and international treaty, and therefore you must treat them like a book, with the exception that you may make copies to protect yourself against loss of the original.

Your right to use the enclosed software and documentation as described below is non-exclusive and non-transferable. Zebra retains ownership in the software and documentation and all other right, title and interest. The enclosed software and documentation may be used by any number of people and may be freely moved from one computer to another as long as there is no possibility of their being used by more than one person on more than one computer at the same time.

Machine readable files representing graphics or fonts which you have created independently may be converted to ZPL format files using the enclosed software and such files may be used, copied onto diskettes or font cards, given away, or sold without paying license fees to Zebra.

Pictorial or graphic images and machine readable files representing them may be protected by United States copyright law and international treaty provisions which prohibits you from transcribing or scanning such images or using copying, or converting such files without permission of the copyright owner. You may not use this software in violation of U.S. copyright law or international treaty. By using this software, you agree to be bound by these terms.

Zebra Technologies Corporation ("Zebra") warrants the enclosed diskette to be free of defects in material and workmanship for a period of 60 days from the date of purchase. In the event of notification within the warranty period of defects in material and workmanship, Zebra will replace the defective diskette or documentation. Zebra specifically disclaims all other warranties, expressed or implied, including but not limited to implied warranties of merchantability and fitness for a particular purpose.

IN NO EVENT WILL ZEBRA TECHNOLOGIES BE LIABLE FOR LOST PROFITS, LOST DATA, OR ANY OTHER INCIDENTAL OR CONSEQUENTIAL DAMAGES CAUSED BY ABUSE OR MISAPPLICATION OF THE SOFTWARE OR BY ITS USE IN VIOLATION OF THE U.S. COPYRIGHT LAW OR INTERNATIONAL TREATY.

Contents

Warranty Information	iii
Printer Warranty	iii
Supplies Warranty	iii
Warranty Exclusions and Conditions.	iii
Zebra Software License Agreement	iv
List of Figures	xi
List of Tables	xii

Getting Started *1*

Introduction.	1
Print Mechanism Capabilities	1
Media Transport Mechanism Capabilities	2
Front Panel Display	2
System Requirements.	2
Media and Ribbon Requirements.	3
Unpacking	3
Reporting Damage.	4
Storage and Reshipping	4
Site Requirements	5
Printer Power-Up	5
Communications	6
Loading Media	6
Introduction to Media Loading	6
Tear-Off Mode Media Loading	8

Cutter Mode Media Loading	11
Rewind Mode Media Loading	11
Peel-Off Mode Media Loading	14
Removing the Label Backing Material	15
Transmissive Media Sensor Position Adjustment.	15
Adjusting the Upper Media Sensor Position.	16
Lower Media Sensor Adjustment	17
Ribbon Loading	18
Ribbon Removal	20

Operation ***21***

Operating Your Zebra XiII-Series Printer	21
Printer Operating Modes	21
Tear-Off Mode	21
Peel-Off Mode	22
Rewind Mode	22
Cutter Mode	22
Operator Controls	23
Power Switch.	23
Front Panel Display	24
Front Panel Keys.	25
Front Panel Lights	26
Printer Status Sensors	27
Initial Printer Power-Up.	28
Configuration and Calibration	29
Entering the Program Mode	29

Changing Password-Protected Parameters	30
Leaving the Program Mode	31
Configuration and Calibration Sequence . . .	32
Sample ZPL II Label Formats	46
Format 1: Simple Text and a Barcode	48
Format 2: Saving a Label Format As a Graphic Image	48
Format 3: Using a Serialized Data Field	49

Routine Care and Adjustment 51

Cleaning	51
Cleaning the Exterior	52
Cleaning the Interior	52
Cleaning the Printhead and Platen Roller . . .	52
Cleaning the Sensors	53
Cleaning the Cutter Module	54
Lubrication	54
Fuse Replacement	54
Adjustments	56
Toggle Positioning	56
Printhead Pressure Adjustment	57
Media Sensor Position Adjustment	57

Troubleshooting and Diagnostics 59

Printer Diagnostics	65
Power-On Self Test	65
Additional Printer Self Tests	65

Options 71

Rewind Option	71
Cutter	71
Internal Fanfold Media Supply Bin	72
Memory SIMMs.	72
Zebra On-Line Verifier	72
Applicator Interface	73
Media Supply Spindle.	73
Optional Media Supply Fins	73
Fonts.	73
PCMCIA Type I Memory Cards	74
KMT Printhead	74
Communication Interfaces	74
IBM [®] Twinax Interface	74
IBM [®] Coax Interface.	74
ZebraNet [™] (Ethernet) Interface	74
RS-485 Interface	75

Specifications 77

Media Handling	77
Options	77
Zebra Programming language (ZPL II [®])	78
Bar Codes	78
General Specifications	79
Printing Specifications	79

Ribbon Specification	80
Media Specifications	81
Power Line Cord Specifications	82
Printer Fonts	83
Standard Printer Fonts	83
Standard Printer Font Examples	84
Optional Printer Fonts	85
Optional Printer Font Examples.	86
<i>Appendix</i>	<i>87</i>
Printer Interface Technical Information.	87
System Considerations.	87
RS-232/RS-422/RS-485 Serial Data Port	88
Parallel Data Port	92
Cabling Requirements	93
ASCII Code Chart.	94
Adjusting Darkness for “In-Spec” Bar Codes.	95
Too Dark	96
Slightly Dark	96
Slightly Light.	96
Too Light.	96
“In-Spec”.	96
<i>Glossary</i>	<i>99</i>
<i>Index</i>	<i>103</i>



List of Figures

1. Media Loading	8
2. Roll Media Loading	9
3. Fanfold Media Loading	10
4. Upper Media Sensor Adjustment	16
5. Lower Media Sensor Adjustment	17
6. Ribbon Loading Diagram for the 90XiII and 140XiII Printers	19
7. Ribbon Loading Diagram for the 170XiII and 220XiII Printers	19
8. Removing Used Ribbon	20
9. Front Panel	24
10. Media and Ribbon Sensor Profile Sample Printout	46
11. Cleaning Diagram	53
12. Fuse Replacement Step 1	55
13. Fuse Replacement Step 2	55
14. Toggle Adjustment	56
15. Cancel Key Self Test Sample Printout	66
16. Pause Key Self Test Sample Printout	67
17. Feed Key Test Sample Printout	69
18. Communications Diagnostics Test Sample Printout	69
19. Power Line Cord	82
20. International Safety Organizations	82
21. Standard Printer Font Examples	84
22. Select Examples of Optional Fonts	86
23. Bitmap Smooth Fonts: Point Size Examples	86
24. RS-232 Connections	89
25. 9 Pin to 25 Pin Interconnecting Cable	90
26. 25 Pin to 25 Pin Interconnecting Cable	90
27. RS-422/RS-485 Interconnecting Cable	91
28. RS-422/RS-485 Connections	91
29. Bar Code Examples	97

List of Tables

1. Front Panel Keys	25
2. Front Panel Lights	26
3. Printer Status Sensors	27
4. Power-On Self Test Sequence	28
5. Cleaning Schedule	51
6. Troubleshooting	59
7. Eight Dots/mm Printhead	83
8. Twelve Dots/mm Printhead	84
9. Optional Printer Fonts Currently Available	85
10. RS-232/RS-422/RS-485 Pinouts	88
11. Parallel Connector Pinouts	92
12. ASCII Code Chart	94

Getting Started

Congratulations! You have just purchased a high-quality thermal demand printer manufactured by the industry leader in quality, service, and value—Zebra Technologies Corporation. For over 25 years, Zebra has provided customers with the highest caliber of products and support.

This manual provides all of the information you will need to operate your printer on a daily basis. To create label formats, refer to the ZPL II Programming Guide (part # 46469L). This guide is available by contacting your distributor or Zebra Technologies Corporation.

There is also a maintenance manual for this printer: The maintenance manual (part # 48452L) contains the information you may need in order to maintain your printer.

Introduction

The XiII printer, when connected to a host computer, functions as a complete system for printing labels, tickets, and tags. The printer receives instructions from the host computer. Microprocessors continuously monitor these signals along with the inputs received from the control panel and various sensors. The microprocessors interpret this information and control the XiII printer's mechanics, printhead, communications, command interpretation, label formatting, media control, and mechanical drive.

Print Mechanism Capabilities

The XiII print mechanism has been designed to print information on labels, tickets, and tags. It uses a square or rectangular dot thermal printhead that heats a ribbon as it passes beneath the print elements, melting its ink onto the media (direct thermal print mode involves using heat-sensitive media instead of an inked ribbon). Print speeds are selected via software control.

Media Transport Mechanism Capabilities

The media transport mechanism of the XiII printer has been designed to accommodate various types of media including die-cut labels, ticket and tag stock, continuous roll media, fanfold media, and black-mark media.

Media may be rewound internally onto standard three-inch cores if the Rewind Option is installed. The Rewind Option also allows backing material to be rewound internally, so that the printer can operate in Peel-Off mode.

Front Panel Display

The XiII printer features a two-line by 16-character-per-line liquid crystal display screen. Operational status, programming modes and parameters, and other messages are displayed here. This display features adjustable backlighting for added visibility.

System Requirements

In addition to the XiII printer, you will need the following items to form a complete label preparation system:

- Label-, ticket-, or tag-stock.
- A device, such as a computer, for data entry and output of label formats.
- A data communication cable to connect the controlling device to the XiII printer. (Remote installations may require additional cables and communication devices such as modems and/or protocol converters.)
- Thermal transfer ribbon (if printing in Thermal Transfer mode).

Media and Ribbon Requirements

Print quality not only depends on the XiII-Series printer but also on the media and ribbon used. Factors such as reflectivity and contrast are important for bar code scanning applications. Factors such as paper abrasion and temperature requirements are important to maintaining printhead life.

We **STRONGLY RECOMMEND** the use of Zebra Technologies Corporation-brand supplies for continuous high-quality printing. A wide range of paper, polypropylene, polyester, and vinyl stock has been specifically engineered to enhance the printing capabilities of the Zebra XiII-Series printer and to ensure against premature printhead wear.

Continuous roll media, fanfold media, or cardstock with optional perforations and registration holes may be used. Printhead life may be reduced by the abrasion of exposed paper fibers when using perforated media.

Ribbons used in the Zebra XiII printer **MUST** be as wide as or wider than the media used. Zebra-brand ribbons provide an extremely smooth backing surface which protects the printhead from abrasion by the media. If the ribbon is narrower than the media, areas of the printhead will be unprotected and will be subject to premature wear.

Since print quality is affected by media and ribbon, printing speeds, and printer operating modes, it is very important to run tests for your applications. This is especially true if you're operating in Peel-Off mode, where these variables combine with label size, backing content, die-cut depth, and even humidity to affect printer operation.

Unpacking

Save the carton and all packing materials in case shipping is ever required. Inspect the printer for possible damage incurred during shipment.

- Check all exterior surfaces.
- Raise the media access door and inspect the media compartment.

Reporting Damage

If you discover shipping damage upon inspection:

- Immediately notify the shipping company of the damage.
- Retain all packaging material for shipping company inspection.
- File a damage report with the shipping company and notify your local distributor and Zebra Technologies Corporation of the damage.

Zebra Technologies Corporation is not responsible for any damage incurred during shipment of the equipment and will not repair this damage under warranty. Immediate notification of damage to the shipping company or its insuring agency will generally result in ensuring any damage claim validity and ultimate monetary compensation.

Storage and Reshipping

If you are not placing the XiII printer into operation immediately, repackage it using the original packing materials. The XiII printer may be stored under the following conditions:

- Temperature: -4° to +140° F (-20° to +60° C)
- Relative humidity: 5 to 85% non-condensing

To ship the Zebra XiII-Series printer, first remove all media and ribbon from the supply and take-up/rewind spindles to prevent damage to the printer. Then carefully pack the printer in a suitable container to avoid damage during transit. Whenever possible, use the original shipping container. If the original shipping container is lost or destroyed, one can be purchased from Zebra Technologies Corporation. If a different container is used, package the printer carefully to avoid damage. Zebra will not be responsible for shipping damage incurred due to improper packaging!

CAUTION: When packaging the printer in a rigid container, use shock mounts or shock-absorbing packing material. A rigid container will allow shock on the outside to be transmitted undamped to the printer which may cause damage.

Site Requirements

CAUTION: To insure that the printer has proper ventilation and cooling, do not place any padding or cushioning material under the unit because this restricts air flow.

The Zebra XiII-Series printer may be installed on any solid, level surface of sufficient size and strength to accommodate the physical dimensions and weight of the unit. The area enclosure in which the printer will operate must meet the environmental conditions specified. Electrical power must be available and in close proximity to the printer.

Since the Zebra XiII-Series printer was designed and is fabricated as an industrial-type unit, it will function satisfactorily in areas such as warehouses, factory floors, and office environments that conform to specified environmental and electrical conditions.

Printer Power-Up

Follow the instructions in this section to connect this printer to a source of electrical power and a data source.

Voltage Selection

The XiII printer auto-adjusts for 90-264 VAC electrical power. No further adjustment is required.

Power Cord

WARNING! For personnel and equipment safety, always use a three-prong plug with a ground (earth) connection.

Make sure that the Power On/Off Switch (located at the back of the printer) is in the off position before connecting the power cable to an electrical outlet.

Depending on how your printer was ordered, a power cord may or may not be included. If one is not included, or if the one included is not suitable for your requirements, refer to “Power Line Cord Specifications” on page 82.

The power cord connector must be plugged into the mating connector on the rear of the printer.

Communications

The XiII printer has been designed with flexible communication capabilities that allow the printer to be interfaced to a variety of controlling devices. A single DB25 connector includes all signals necessary for interfacing the printer to RS-232, RS-422, or RS-485 serial data communication devices at data rates from 110 to 57,600 baud. Baud rate, parity, data length, number of stop bits, and handshaking protocol are programmable via the front panel display and keypad.

A parallel data communication port is also provided. This port allows data to be sent to the printer at a higher speed than serial communications and still permits printer status information to be sent back to the host via the RS-232 serial port.

CAUTION: Zebra printers comply with international regulations governing radiated emissions when using fully shielded data cables. Data cables must be fully shielded and fitted with metal or metalized connector shells. Shielded data cables and connectors are required to prevent radiation and reception of electrical noise. Use of unshielded data cables may increase radiated emissions above the regulated limits.

Loading Media

Introduction to Media Loading

NOTE: A Calibration must be performed when media and ribbon (if used) are first installed in the printer and when a different type of media or ribbon is installed. See “Media and Ribbon Sensor Calibration” on page 36.

NOTE: Media widths and thicknesses vary between applications. To maintain print quality from one application to another, refer to “Adjustments” on page 56.

Non-Continuous Media

This type of media has some type of physical characteristic (gap, notch, perforation, etc.) which indicates the start/end of each label. The Media Sensor must be properly positioned to sense these indicators. See “Transmissive Media Sensor Position Adjustment” on page 15.

Continuous Media

Since continuous media does not contain label start/end indicators, you must tell the printer via software how long each label is. If you are using ZPL or ZPL II, include a Label Length (^LL) instruction in each label format you send to the printer (refer to your ZPL II Programming Guide). If you are using other software to communicate with your printer, refer to the instructions provided with that software.

Black-Mark Media

This type of media has black marks printed on the back that indicate the start/end of each label. The Reflective Media Sensor detects these marks, which allows the printer to differentiate between labels. It is generally used with a cutter to separate the labels because there is no gap between the labels to allow them to be peeled off.

To load media, refer to Figures 1 through 3 and follow the loading procedure for your application. This section details the media loading instructions for the printer. For descriptions of the operating modes, refer to the Operation section.

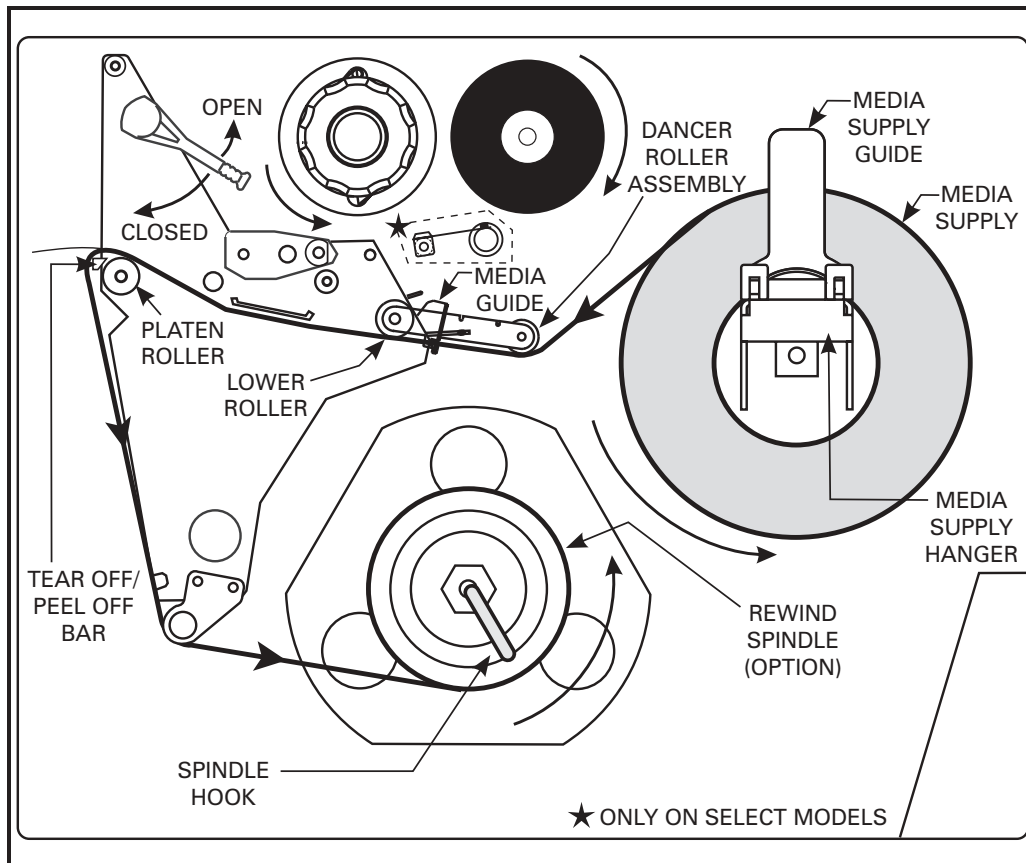

Figure 1. Media Loading

Tear-Off Mode Media Loading

Figure 1 illustrates the method of loading media. First, move the Printhead Open Lever counterclockwise to the open position and raise the printhead. Second, slide the Media Guide and the Media Supply Guide as far out from the printer frame as possible and flip down the Media Supply Guide.

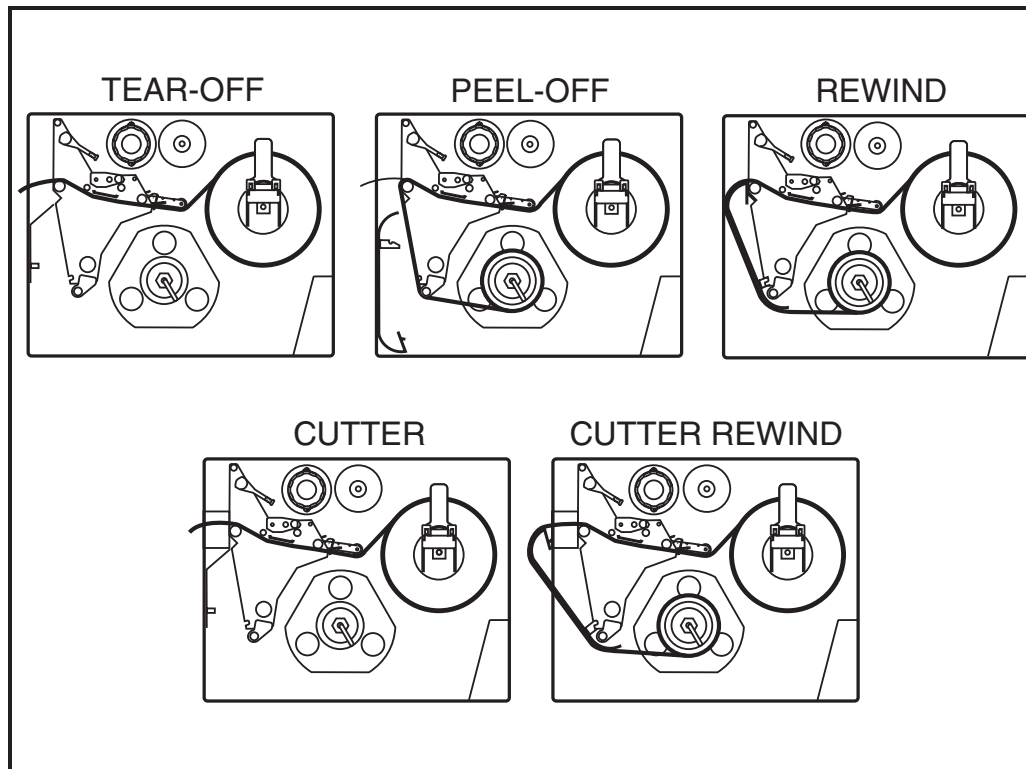

Figure 2. Roll Media Loading

Roll Media Loading

Place the media roll on the Media Supply Hanger and thread the media through the printhead assembly as shown in the “Tear-Off” loading part of Figure 2. Flip up the Media Supply Guide and adjust the Media Supply Guide and the Media Guide against the outer edge of the media. These guides must not cause pressure or excessive drag on the media. Close the Printhead Open Lever and see “Transmissive Media Sensor Position Adjustment” on page 15.

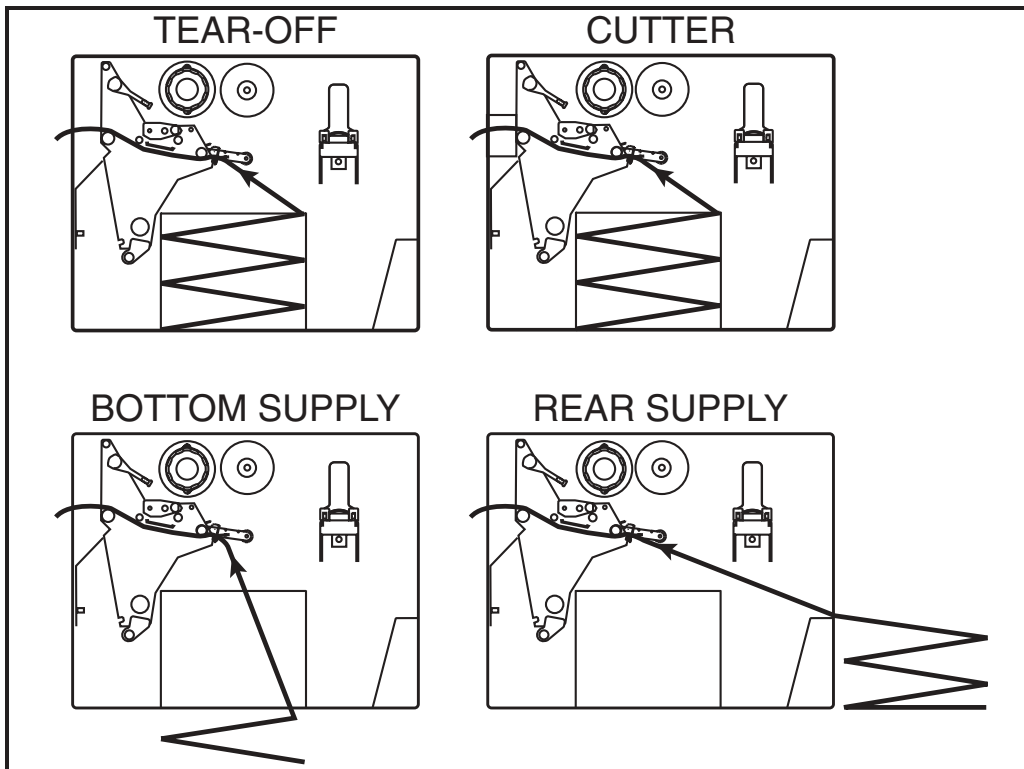

Figure 3. Fanfold Media Loading

Fanfold Media Loading

Fanfold media, from outside the printer, feeds through either the bottom or rear access slot. You may also use the Fanfold Supply Bin to hold media inside the printer housing.

To load fanfold media, thread the media through the Printhead Assembly as shown in Figure 3. Adjust the Media Guide against the outer edge of the media. This guide must not cause pressure or excessive drag on the media. Close the Printhead Open Lever, and turn to “Transmissive Media Sensor Position Adjustment” on page 15.

Continuous Media Loading

Continuous media mounts inside the printer in the same manner as roll media. For proper printer operation, a label length instruction must be included in the label format sent to the printer.

Cutter Mode Media Loading

(Cutter Option Required)

To ensure proper media loading, follow the directions for the Tear-Off Mode with the exception that the media must also be routed through the Cutter Module as shown in Figures 2 and 3.

Close the Printhead Open Lever. The printer will automatically feed out and cut one label when the printer is powered on. Turn to “Transmissive Media Sensor Position Adjustment” on page 15.

Rewind Mode Media Loading

(Rewind Option Required)

NOTE: For best results, install the printer on a level surface. This is especially helpful with wider printers using wide media. If the surface is not level, the media may “telescope” off of the Rewind Spindle, causing unsatisfactory results.

Rewind Mode for Printers Without the Cutter Option

1. Remove the Media Rewind Plate from its storage location in front of the print mechanism inside the media compartment.
2. Invert the Rewind Plate so that the lip on the attached Hook Plate points down.
3. Insert the Hook Plate lip a short distance ($\frac{1}{2}$ ") into the lower opening in the Side Plate.

4. Align the upper end of the Rewind Plate with the corresponding opening in the Side Plate and slide the Rewind Plate in so that it stops against the printer's main frame.
5. Load the media as described in the instructions for Roll Media Loading on page 9. When loading the media, allow about one yard of media to extend past the Tear-Off bar. If using label stock remove all labels from this portion of the media to create a leader.
6. Remove the Spindle Hook from the Rewind Spindle. If you are using a core, remove all tape from the core and slide it onto the Rewind Spindle until it is flush against the guide plate.
7. Route the media as shown in Figures 1 and 2 and wind it once or twice around either (1) the Rewind Spindle and reinstall the Hook, or (2) a 3" core. (With some media, especially tag stock, you may need to tape the end of the media to the core if it will not otherwise tighten onto the core. DO NOT tape the label stock unless absolutely necessary.)

NOTE: Before closing the Printhead Open Lever, make sure that the following guidelines are met:

- the media is positioned against the inside guides, and the outer guide and Media Supply Guide barely touch the media
 - the media is taut
 - the media is parallel with itself and with the pathway when wound on the Rewind Spindle/core
8. Media loading is now complete. See "Transmissive Media Sensor Position Adjustment" on page 15.

Rewind Mode for Printers With the Cutter Option

1. Remove the Media Rewind Plate from its storage location in front of the print mechanism inside the media compartment.
2. Invert the Rewind Plate so that the lip on the attached Hook Plate points down.

3. Insert the Hook Plate lip a short distance ($\frac{1}{2}$ ") into the lower opening in the Side Plate and slide the Rewind Plate in so that it stops against the printer's main frame.
4. Insert the two small tabs on the Rewind Plate into the corresponding slots in the Cutter Support Bracket. (The Rewind Plate should spring into the proper position.)
5. Load the media as described in the instructions for Roll Media Loading on page 9. When loading the media, allow about one yard of media to extend past the Tear-Off bar. If using label stock remove all labels from this portion of the media to create a leader.
6. Remove the Hook from the Rewind Spindle. If you are using a core, remove all tape from the core and slide it onto the Rewind Spindle until it is flush against the guide plate.
7. Route the media as shown in Figures 1 and 2 and wind it once or twice around either (1) the Rewind Spindle and reinstall the Hook, or (2) a 3" core. (With some media, especially tag stock, you may need to tape the end of the media to the core if it will not otherwise tighten onto the core. DO NOT tape the label stock unless absolutely necessary.)

NOTE: Before closing the Printhead Open Lever, make sure that the following guidelines are met:

- the media is positioned against the inside guides, and the outer guide and Media Supply Guide barely touch the media
 - the media is taut
 - the media is parallel with itself and with the pathway when wound on the Rewind Spindle/core
8. Media loading is now complete. See "Transmissive Media Sensor Position Adjustment" on page 15.

Peel-Off Mode Media Loading

(Rewind Option Required)

NOTE: For best results, install the printer on a level surface. This is especially helpful with wider printers using wide media. If the surface is not level, the media may “telescope” off of the Rewind Spindle, causing unsatisfactory results.

1. Remove the Rewind Plate if one is present on the front of the printer and store it on the two mounting screws on the inside of the front panel. Align the notch in the bracket so the Label Available Sensor (shown in Figure 14 on page 56) can detect a peeled label.
2. Load the media as described in the instructions for Roll Media Loading on page 9. When loading the media, allow about one yard of media to extend past the Tear-Off bar. Remove all labels from this portion of the media to create a leader.
3. Remove the Hook from the Rewind Spindle. If you are using a core, remove all tape from the core and slide it onto the Rewind Spindle until it is flush against the guide plate.
4. Wind the backing around either (1) the Rewind Spindle and reinstall the hook or (2) a 3” core. Make sure that the media backing is against the Backing Guide Plate.

NOTE: Before closing the Printhead Open Lever, make sure that the following guidelines are met:

- the media is positioned against the inside guides, and the outer guide and Media Supply Guide barely touch the media
 - the media is taut
 - the media is parallel with itself and with the pathway when wound on the Rewind Spindle/core
5. See “Transmissive Media Sensor Position Adjustment” on page 15.

Removing the Label Backing Material

(Rewind Option Required)

Since the Backing Rewind Spindle holds the backing from a standard-size media roll, we recommend that you perform this procedure whenever you change the media.

To remove the backing material from the Backing Rewind Spindle, follow these steps (you don't need to turn the printer power off for this procedure).

1. Unwind about one yard (one meter) of backing from the Backing Rewind Spindle and cut it off at the spindle.
2. Pull out the Spindle Hook and slide the backing material off of the spindle and discard.
3. Wind the media around the Rewind Spindle once or twice and reinstall the Spindle Hook. Continue winding to remove any slack in the media.

Transmissive Media Sensor Position Adjustment

When the XiII printer is powered on, it performs a self test and configures its operating characteristics. Some of these characteristics are determined by the position of the Transmissive Media Sensor. The factory-set position is sufficient for most types of media. However, if media sensor position adjustments are needed, follow the procedures below.

NOTE: The Reflective (Black-Mark) Media Sensor position is not adjustable; it is positioned to accommodate all black-mark media that meets the specifications listed in “Media Specifications” on page 81.

NOTE: If you are using continuous media (no gap, notch, or hole between labels) or black-mark media, position the transmissive sensor over the media so that the printer can detect an out-of-paper condition. The factory-set position should be sufficient for this purpose.

The Transmissive Media Sensor consists of two sections. The media passes between a light source (Lower Media Sensor) and a light sensor (Upper Media Sensor).

This adjustment aligns the position of the Upper and Lower Media Sensors with the notch or edge of the label.

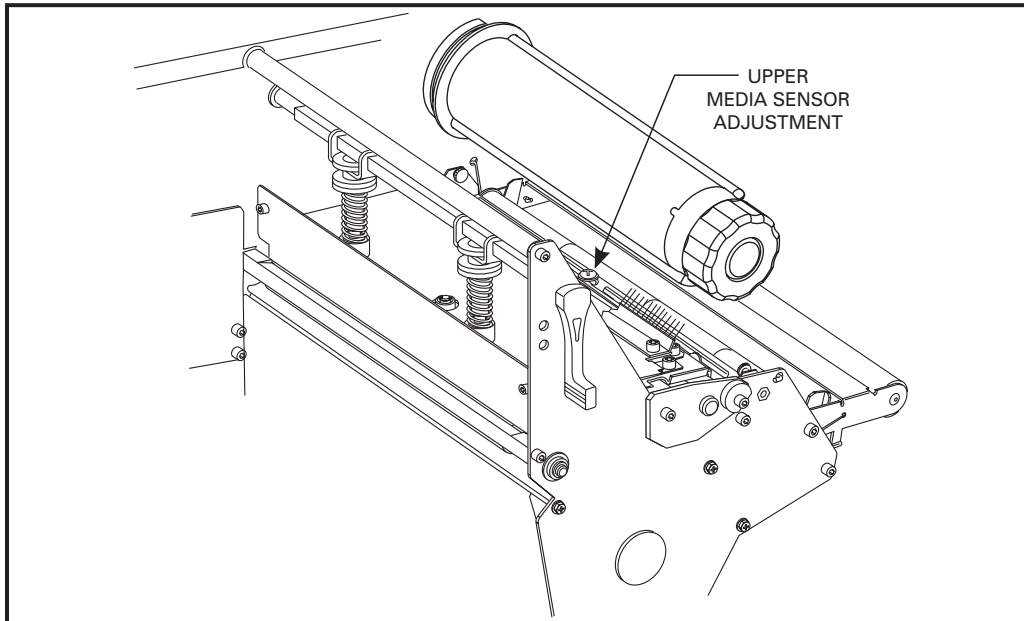

Figure 4. Upper Media Sensor Adjustment

Adjusting the Upper Media Sensor Position

NOTE: If you own a 140XiII or 170XiII printer and need to move the sensor to the outside half of the maximum media width, or from the outside half to the inside half, contact a service technician to perform this procedure because it will require additional steps which are beyond the scope of this user's guide.

To adjust the upper media sensor, follow these steps.

1. Remove ribbon if it is installed.

2. Locate the Upper Media Sensor. Refer to Figure 4. The Upper Media Sensor is directly below the adjustment screw head.
3. Loosen the Upper Media Sensor Adjustment screw (Phillips head).
4. Slide the upper sensor along the slot to the desired position. When using label stock that has a gap between labels (die-cut label stock), position the media sensor anywhere along the gap EXCEPT where the rounded corners of the label are detected. When using tagstock, position the upper sensor directly over the hole or notch.
5. Tighten the screw.

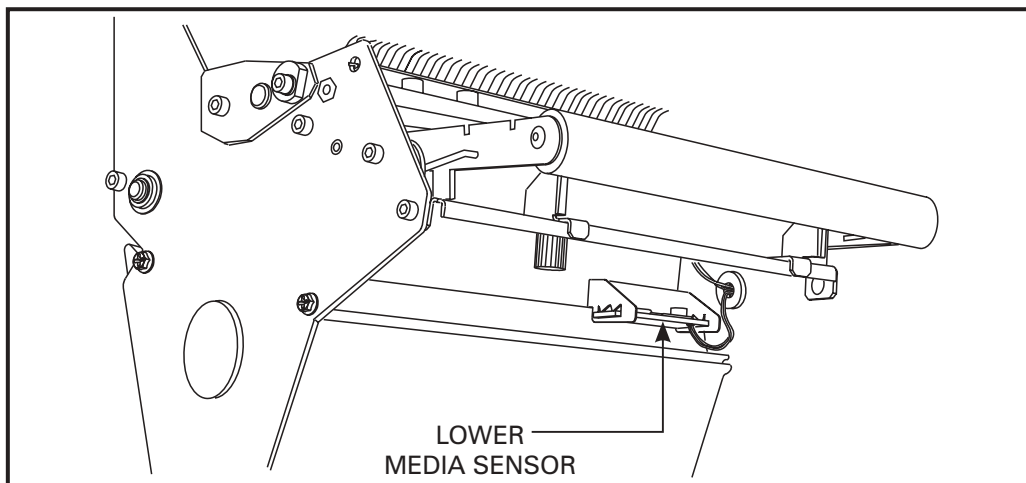

Figure 5. Lower Media Sensor Adjustment

Lower Media Sensor Adjustment

Refer to Figure 5 throughout this procedure.

1. Locate the Lower Media Sensor assembly (a spring clip holding a circuit board) near the bottom rear of the printhead assembly.
2. Position the sensor by sliding it in its slot so that the two brass-colored infrared emitters are centered under the upper sensor.

3. If you are moving the sensor away from the printer's main frame: Gently pull wires out of the printer frame as required. (Wires should have a little slack.) Call a service technician if there is not enough slack in the wires to adjust the sensor to the desired position. If you are moving the sensor toward the printer's main frame and a large loop of wire develops, call a service technician to properly adjust the wires.

Ribbon Loading

To load ribbon, refer to Figures 6 and 7 and follow the procedure below.

NOTE: Use ribbon that is at least as wide as the media. The smooth backing of the ribbon protects the printhead from wear and premature failure due to excessive abrasion. (*For Direct Thermal Print Mode, ribbon is not used and should not be loaded in the printer.*)

1. Align the segments of the Ribbon Supply Spindle.
2. Place the ribbon roll on the Ribbon Supply Spindle.

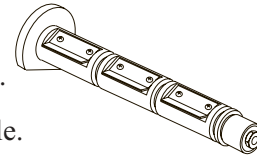

NOTE: Make sure that the core is pushed up against the stop on the ribbon supply spindle and that the ribbon is aligned squarely with its core. If this is not done, the ribbon may not cover the printhead entirely on the inside, thereby exposing print elements to potentially damaging contact with the media.

3. Open the Printhead by moving the Printhead Open Lever counterclockwise to the "open" position.
4. (Optional) To make ribbon loading and unloading easier, make a leader for your ribbon roll if it doesn't already have one.

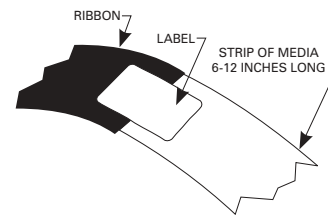

Tear off a strip of media (labels and backing) about 6 to 12 inches long from the roll. Peel off a label from this strip.

Apply half of this label to the end of the strip and the other half to the end of the ribbon. This acts as a ribbon leader.

5. Thread the ribbon (with leader, if used) as shown without creasing or wrinkling it.
6. Before wrapping the ribbon around the Take-Up Spindle, ensure that the arrow on the knob aligns with the indented notch (see Figure 8 inset).

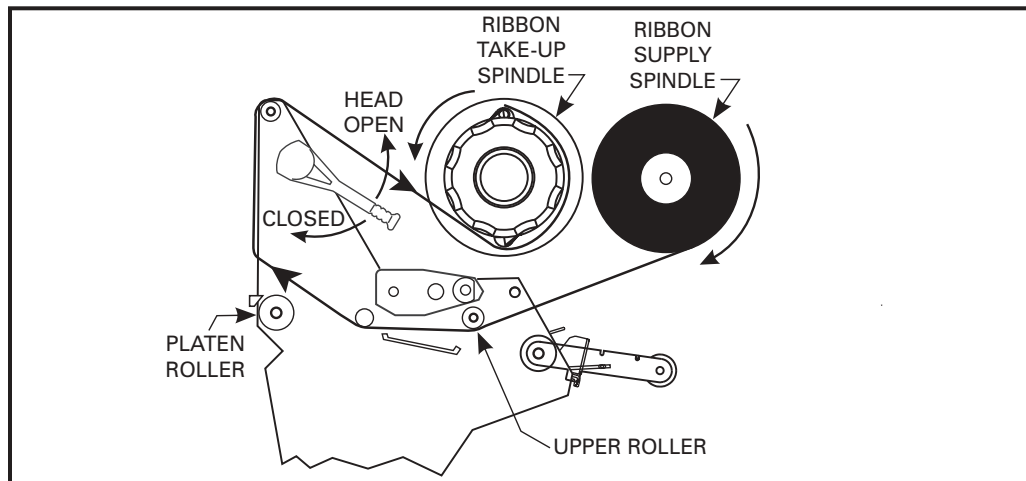

Figure 6. Ribbon Loading Diagram for the 90XiII and 140XiII Printers

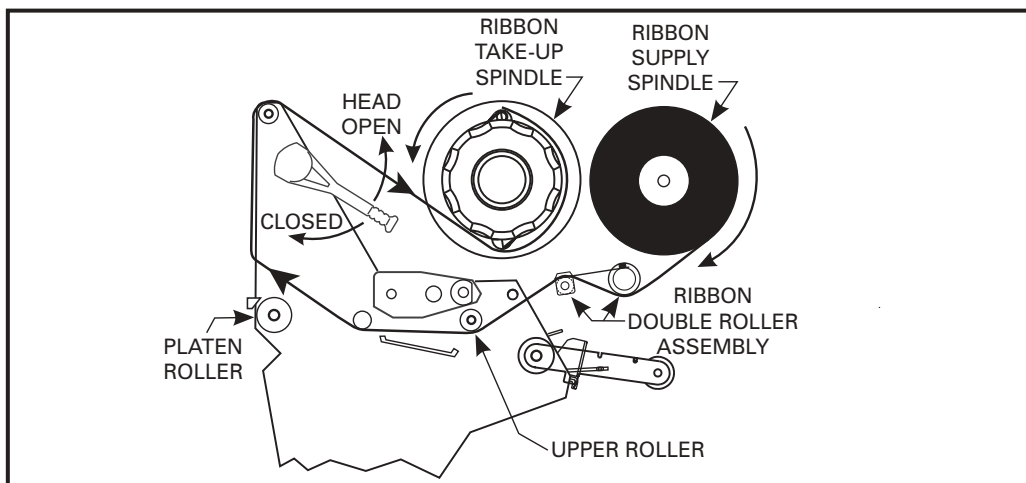

Figure 7. Ribbon Loading Diagram for the 170XiII and 220XiII Printers

7. Place the ribbon (with leader, if used) around the Ribbon Take-Up Spindle and wind counterclockwise for several turns.
8. Close the Printhead by moving the lever clockwise to the “closed” position.

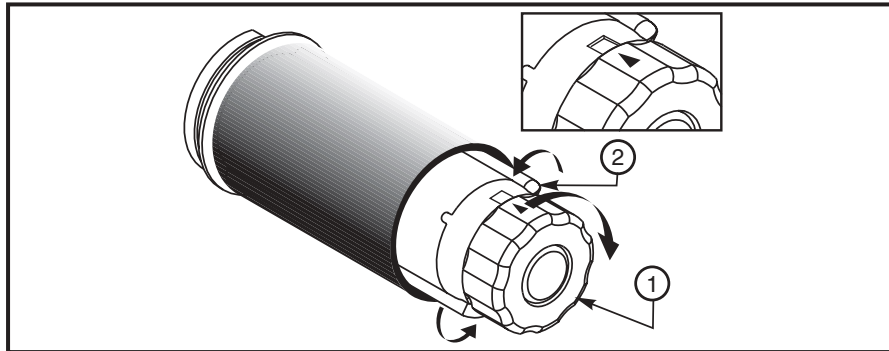

Figure 8. Removing Used Ribbon

Ribbon Removal

1. Break the ribbon as close to the Ribbon Take-Up Spindle as possible.
2. Refer to Figure 8. While holding the Ribbon Take-Up Spindle, turn the knob (1) clockwise until it stops. This will cause the Ribbon Release Bars to pivot down (2), easing the spindle’s “grip” on the wound ribbon.
3. Slide the ribbon off of the Ribbon Take-Up Spindle. Once the used ribbon has been removed, ensure that the arrow on the knob aligns with the indented notch in the Ribbon Take-Up Spindle (see inset).
4. Remove the empty core from the Ribbon Supply Spindle.
5. Follow the Ribbon Loading procedure on page 18 to load the new ribbon.

Operation

Operating Your Zebra *XiII*-Series Printer

Now that your printer is ready for operation, how does it work? The Zebra *XiII*-Series printer is designed to receive instructions from a host computer, such as an IBM-compatible PC. To create a label, you will either need to write a format in ZPL II, which is a programming language for creating label formats, or you will need to use a software program designed to format labels for the Zebra *XiII*-Series printer. If you are using label design software, refer to the instructions provided with your software package to determine how to do this.

If you are using, or plan to use, ZPL II programming language to format your labels, make sure you have a copy of the ZPL II Programming Guide. Refer to the mail/fax-in card at the front of this book to obtain a copy. For some sample ZPL II label formats, refer to page 46.

Printer Operating Modes

The *XiII* printer can be configured for one of several different operating modes by sending the proper commands from the host computer or by configuring the printer for a certain mode using the front panel display.

Tear-Off Mode

When the media is in the rest (idle) position, the gap between labels is over the Tear-Off/Peel-Off Plate. The operator then tears off the label, and a new label may be printed.

This mode of operation may also be used to print a large quantity of labels. To do this, send a format for printing a batch of labels to the printer. The printing will continue until all labels have been printed.

Peel-Off Mode

(Peel-Off Option Required)

In this mode, once the label is printed the media passes over the Tear-Off/Peel-Off Plate at a sharp angle. The backing material is peeled away from the label and winds around the Backing Rewind Spindle. The media feeds forward until most of the label hangs loose from the backing. The Label Available Sensor detects this label and pauses printing until the operator removes the label, at which time the next label prints.

The Backing Rewind Spindle will hold the backing from a standard-size media roll. To remove the backing from the Rewind Spindle, refer to page 15.

Rewind Mode

(Rewind Option Required)

In this mode, the media and backing are rewound onto a core as the labels are printed.

When the media is in the rest (idle) position, the start of the next label is directly under the printhead. After the label is printed, the media feeds forward until the start of the next label is under the printhead. The media never backfeeds in this mode. The completed labels are rewound onto a core for later use. When the printer completes a batch of labels, printing will stop.

Cutter Mode

(Cutter Option Required)

In this mode, the printer prints the entire label and automatically cuts the label after it is printed. The Cutter Catch Tray “catches” the completed labels.

Operator Controls

This section discusses the functions of the various controls and indicators on the XiII printer. The operator should become familiar with each of these functions.

Power Switch

This switch is located on the back of the printer above the Power Cord and Fuse. The Power Switch should be turned off before connecting or disconnecting any cables.

Turning the switch on activates the printer and causes it to perform a Power-On Self Test as it begins operation. Turning the printer power on while holding down certain front panel keys will launch additional Printer Self Tests following the Power-On Self Test.

External influences such as lightning storms or unwanted noise on the power or data cables may cause erratic printer behavior. Turning the printer's power off and back on may re-establish proper printer operation.

Front Panel Display

The Front Panel Display communicates operational status and programming modes and parameters.

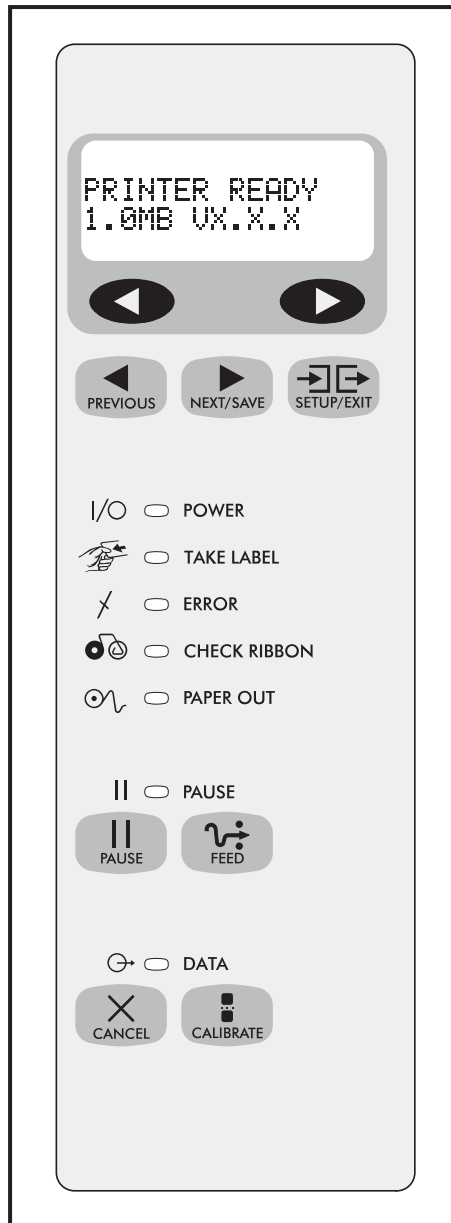

















Figure 9. Front Panel

Front Panel Keys

Table 1. Front Panel Keys	
Key	Function
	<p>Starts and stops the printing process.</p> <ul style="list-style-type: none"> If the printer is not printing: no printing can occur If the printer is printing: printing stops once the current label is complete <p>Press to remove error messages from the display.</p> <p>NOTE: Pause Mode can also be activated via ZPL II (~PP, ^PP).</p>
	<p>Forces the printer to feed one blank label each time the key is pressed.</p> <ul style="list-style-type: none"> Printer not printing: one blank label feeds immediately Printing: one blank label feeds after the current batch of labels is complete <p>NOTE: Equivalent to the Slew to Home Position (~PH, ^PH) ZPL II instruction.</p>
	<p>When in the Pause mode, this key will cancel print jobs.</p> <ul style="list-style-type: none"> Print job in queue: press once for each print job to be deleted. Press and hold for several seconds to cancel all print jobs in the printer's memory. The Data light will turn off.
	<p>When in Pause mode, this key will calibrate the printer for:</p> <ul style="list-style-type: none"> Media length Media type (continuous or non-continuous) Print mode (direct thermal or thermal transfer)
<p>NOTE: The keys below are used only when configuring the printer. Specific uses of these keys are explained in the Configuration and Calibration topic, starting on page 29.</p>	
	<p>Scrolls back to the previous parameter.</p>
	<p>Scrolls forward to the next parameter. Saves any changes you've made in the Configuration and Calibration sequence.</p>
	<p>Enters and exits the configuration mode.</p>
	<p>These keys change the parameter values. They are used in different ways depending on the parameter displayed. Common uses are: increase/decrease a value, answer "yes" or "no", indicate "on" or "off", scroll through several choices, input the password.</p>

Front Panel Lights

NOTE: If two operating conditions occur simultaneously, one which causes a light to be on constantly and one which causes the same light to flash, the light will flash.

Table 2. Front Panel Lights		
Light	Status	Indication
Power I/O 	Off	Printer is off or power is not applied.
	On	Printer is on.
Take Label 	Off	Normal operation.
	Flashing	(Peel-Off Mode Only) Label is available. Printing is paused until the label is removed.
Error 	Off	Normal operation—no printer errors.
	Flashing	Printer error exists. Check the display screen for more information.
Check Ribbon 	Off	Normal operation—ribbon (if used) is properly loaded.
	On	Printing is paused, the front panel displays a warning message, and the Pause light is on. <ul style="list-style-type: none"> • If the printer is in Direct Thermal mode: Ribbon is loaded. • If the printer is in Thermal Transfer mode: No ribbon is loaded.
Paper Out 	Off	Normal operation—media is properly loaded.
	On	No media is under the media sensor. Printing is paused, the display shows an error message, and the Pause light is on.
Pause II 	Off	Normal operation.
	On	Printer has stopped all printing operations. Either the Pause key was pressed, a pause command was included in the label format, the on-line verifier detected an error, or a printer error was detected. Refer to the display screen for more information.
Data 	Off	Normal operation, no data being received or processed.
	On	Data processing or printing is taking place. No data is being received.
	Flashing	Printer is receiving data from the host computer. Flashing slows when the printer cannot accept more data, but returns to normal once data is again being received.

Printer Status Sensors

Zebra XiII-Series printer contains several status sensors. These sensors alert the operator to various conditions by either stopping the printing or turning on a light. Sensors are described in Table 3.

Table 3. Printer Status Sensors		
Sensor	What It Monitors	How It Works
Printhead Position Sensor	Checks the open/closed status of the printhead lever.	If the printhead is open, the Error light flashes.
Printhead Temperature Sensor	Checks the temperature of the printhead.	If the printhead is too cold, the front panel display indicates this condition and printing continues while the printhead warms up. If the printhead is too hot, printing stops while the printhead cools to standard operating temperature.
Transmissive Media Sensor	Checks for proper media loading.	The Paper Out light will turn on if you run out of media. This condition will also occur if you are using non-continuous media and the media does not move because it is jammed.
	If non-continuous media is used, this sensor detects the label length for individual labels.	
Reflective Media Sensor	Detects the presence of black marks on the back of black-mark media.	If it detects a black mark, the printer knows that it is at the beginning of a label.
Ribbon Sensor	Monitors the presence of ribbon.	If you run out of ribbon, the Check Ribbon light turns on.
Label Available Sensor	In Peel-Off Mode, it checks to see if a label is available.	Once a label prints, it will pass between the two parts of this sensor and cause the printer to pause. The Take Label light turns on. When the label is removed, printing resumes and the light turns off.

Initial Printer Power-Up

Each time you turn the printer on, it automatically performs a self-test called the Power-On Self Test (POST).

Turn the printer on now by pressing the Power Switch at the rear of the printer. The Front Panel Power-On indicator will light up. The other front panel indicator lights and the Liquid Crystal Display (LCD) monitor the progress of the Power-On Self Test (POST). The self test sequence is shown in Table 4.

The POST prompts are in English unless an error occurs, in which case the display cycles through all available languages repeatedly. However, you may change the display language for all other prompts. Refer to “Selecting the Display Language” on page 45.

NOTE: If the printer fails any of these tests, the word “FAILED” will be added to the display. If this occurs, refer to the Troubleshooting and Diagnostics section (starting on page 59).

If loading the printer with media and ribbon for the first time, or changing the type of media, perform the Calibration procedure on page 36.

Table 4. Power-On Self Test Sequence		
This sequence occurs each time the printer is powered up.		
	Front Panel Display	Description
1		All indicator lights turn on simultaneously. Then, through the following steps, they turn off in sequence starting at the bottom.
2		Three different sets of characters will be displayed to verify that the display screen is working properly.
3	SRAM TEST	SRAM functionality test performed.
4	OPTION ROM TEST	Optional ROM functionality test performed. (The words “NOT INSTALLED” will be added to display if no optional ROM is used.)
5	PRINthead TEST	Printhead is checked for proper operation.
6	PROCESSOR TEST	Processor functionality test performed.
7	E-CUBED TEST	E-Cubed functionality test performed.

Front Panel Display		Description
8	EEPROM TEST	EEPROM functionality test performed.
9	MEMORY CARD TEST	Memory Card functionality test performed. (“NOT INSTALLED” will be added to the display if no card is present.)
10		Depending on how the label format was set up, the printer will feed to the first web or label length, calibrate ribbon and media sensors, set label length and feed one or more labels, or no media may be fed. The ZPL II command that controls this is ^MF.
11	PRINTER READY	Printer is ready for operation.

Configuration and Calibration

After you have installed the media and ribbon and the POST (Power-On Self Test) is complete, the front panel display will show “PRINTER READY.” You may now set printer parameters for your application using the front panel display and the five keys directly below it.

If it becomes necessary to restore the initial printer defaults, see “Feed Key and Pause Key Self Test” on page 68.

NOTE: Unless otherwise noted, all parameters are listed in the order they are displayed, starting with “DARKNESS”.

Entering the Program Mode

To enter the programming mode, press the Setup/Exit key. Press either the Next/Save key or Previous key to scroll to the parameter you wish to set. Parameters in this section are shown in the order displayed when pressing the Next/Save key. Throughout this process, press the Next/Save key to continue to the next parameter; or, press the Previous key to go back to the previous parameter in the cycle.

An asterisk (*) in the upper left hand corner of the display indicates that the value displayed is different than the currently stored value.

Changing Password-Protected Parameters

Certain parameters are password-protected by factory default.

CAUTION: Do not change password-protected parameters unless you're sure you know what you're doing! If they are set incorrectly, these parameters could cause the printer to function in an unpredictable way.

The first attempt to change one of these parameters (pressing one of the black oval keys) will require you to enter a four-digit password. This is done via the “ENTER PASSWORD” display. The left black oval key changes the selected digit position. The right black oval key increases the selected digit value. After entering the password, press the Next/Save key. The parameter you are trying to change will be displayed. If the password was entered correctly, you can now change the value.

The default password value is 1234. The password can be changed using the ^KP (Define Password) ZPL II instruction.

NOTE: Once the password has been entered correctly, it will not have to be entered again unless you leave and re-enter the programming mode using the Setup/Exit key.

NOTE: You can disable the password protection feature so that it no longer prompts you for a password by setting the password to 0000 via the ^KP0 ZPL/ZPL II command. To re-enable the password-protection feature, send the ZPL/ZPL II command ^KPx, where “x” can be any number, 1-4 digits in length, except 0.

Leaving the Program Mode



You can leave the Program Mode at any time by pressing the Setup/Exit key. The SAVE CHANGES display will appear. There are five choices, described below. Pressing the left or right black oval key displays other choices and pressing the Next/Save key selects the displayed choice.



- PERMANENT - permanently saves the changes. Values are stored in the printer even when power is turned off.
- TEMPORARY - saves the changes until changed again or until power is turned off.
- CANCEL - cancels all changes since pressing the Setup/Exit key except the Darkness and Tear-Off settings (if they were changed).
- LOAD DEFAULTS - loads factory defaults. The factory defaults are shown on the following pages.





NOTE: Loading factory defaults will require printer calibration and resetting the Head Resistor value.





- LOAD LAST SAVE - loads values from the last Permanent Save.

Configuration and Calibration Sequence

Press	Display Shows	Action/Explanation
----	PRINTER READY	Normal printer operation.
Setting Print Parameters		
	DARKNESS	<p>Adjusting Print Darkness Press the right oval key to increase darkness. Press the left oval key to decrease darkness. Default: +10 Range: 0 to +30</p> <p>Darkness settings are dependent upon a variety of factors including ribbon type, media, and the condition of the printhead. You may adjust the darkness for consistent high quality printing.</p> <p>If printing is too light, or if there are voids in printed areas, you should increase the darkness. If printing is too dark, or if there is spreading or bleeding of printed areas, you should decrease the darkness.</p> <p>The "Feed Key Self Test" on page 68 can also be used to determine the best darkness setting. Since the Darkness setting takes effect immediately, you can see the results on labels that are currently printing.</p> <p>CAUTION: Set the Darkness to the lowest setting that provides good print quality. Darkness set too high may cause ink smearing and/or it may burn through the ribbon.</p>
	TEAR OFF	<p>Adjusting the Tear-Off Position Press the right oval key to increase the value, press the left oval key to decrease the value. Each depression of the key adjusts the Tear-Off position by four dot rows. Default: +0 Range: -64 to +64</p> <p>This parameter establishes the position of the media over the tear bar after printing. The label and backing can be torn off or cut between labels.</p>
	PRINT MODE	<p>Selecting Print Mode Press the right or left oval key to display other choices. Default: Tear-Off Selections: Tear-Off, Peel-Off, Cutter, Rewind, Applicator</p> <p>Print mode settings tell the printer the method of media delivery that you wish to use. Be sure to select a print mode that your hardware configuration supports since some selections displayed are for optional printer features.</p>

Press	Display Shows	Action/Explanation
	MEDIA TYPE	<p>Setting Media Type Press the right or left oval key to display other choices. Default: Continuous Selections: Continuous, Non-continuous</p> <p>This parameter tells the printer the type of media you are using. Selecting continuous media requires that you include a label length instruction in your label format (^LLxxxx if you are using ZPL or ZPL II).</p> <p>When non-continuous media is selected, the printer feeds media to calculate label length (the distance between two detections of the inter-label gap, webbing, or alignment notch or hole).</p>
	SENSOR TYPE	<p>Setting the Sensor Type Press the right or left oval key to display other choices. Default: Web Selections: Web, Mark</p> <p>This parameter tells the printer whether you are using media with a web (gap/space between labels, notch, or hole) to indicate the separations between labels or if you are using media with a black mark printed on the back. If your media does not have black marks on the back, leave your printer at the default (Web).</p>
	PRINT METHOD	<p>Selecting Print Method Press the right oval key for the next value; press the left oval key for the previous value. Default: Thermal Transfer Selections: Thermal Transfer, Direct Thermal</p> <p>The print method parameter tells the printer the method of printing you wish to use: direct thermal (no ribbon) or thermal transfer (using thermal transfer media and ribbon).</p> <p>NOTE: Selecting direct thermal when using thermal transfer media and ribbon creates a warning condition, but printing will continue.</p>

Press	Display Shows	Action/Explanation
	PRINT WIDTH	<p>Setting Print Width Press the right oval key to increase the value, press the left oval key to decrease the value. To change the unit of measurement, press the left oval key until the unit of measurement is active, then press the right oval key to toggle to a different unit of measure (inches, mm, or dots).</p> <p>Default:, Range: The default and range of acceptable values varies depending on what printer you have. Refer to "Printing Specifications" on page 79 for further information about the ranges available for your model.</p> <p>Select a print width that is closest to your media, but AT LEAST as wide. Print width tells the printer the width of the media you are using. Setting width too narrow may result in unprinted portions of your label format. Setting width too wide wastes formatting memory and may cause printing off the right side of the label.</p>
	MAXIMUM LENGTH	<p>Setting Maximum Length Press the left oval key to decrease the value, press the right oval key to increase the value.</p> <p>Default:, Range: The default and range of acceptable values varies depending on your printer's configuration. Values are adjustable in 1.0 inch (25.4 mm) increments.</p> <p>Maximum Length is used in conjunction with the Calibration procedure. The value of this setting determines the maximum label length that will be used during the media portion of the calibration process. Only a few labels are required to set media sensors. Always set the value that is closest to, but not lower than, the length of the label you are using. For example, if the length of the label is 14.5 inches, set the parameter for 15.0 inches (381 mm).</p>
Listing Printer Information		
	LIST FONTS	<p>List Fonts Press the right oval key to print a label listing all of the available fonts.</p> <p>This selection is used to print a label that lists all of the fonts currently available in the printer, including standard printer fonts plus any optional fonts. Fonts may be stored in RAM, in Font EPROMs, or on Font Cards.</p>
	LIST BAR CODES	<p>List Bar Codes Press the right oval key to print a label listing all of the available bar codes.</p> <p>This selection is used to print a label that lists all of the bar codes currently available in the printer.</p>

Press	Display Shows	Action/Explanation
	LIST IMAGES	<p>List Images Press the right oval key to print a label listing all of the available images.</p> <p>This selection is used to print a label that lists all of the images currently stored in the printer's RAM, optional EPROM, or on an optional memory card.</p>
	LIST FORMATS	<p>List Formats Press the right oval key to print a label listing all available formats.</p> <p>This selection is used to print a label that lists all of the formats currently stored in the printer's RAM, optional EPROM, or on an optional memory card.</p>
	LIST SETUP	<p>List Setup Press the right oval key to print a label listing the current printer configuration.</p> <p>This selection is used to print a label that lists the current printer configuration information. (Same as Cancel Key Self Test.)</p>
	INITIALIZE CARD	<p>Initialize Memory Card </p> <p>CAUTION: Initializing will erase all previously stored information from the memory card.</p> <p>Press the right oval key to select "yes" and proceed to the verification menu. If your printer is set to require a password, you will now be prompted to enter the password.</p> <p>This selection initializes the memory card.</p> <p>ARE YOU SURE?</p> <p>Press the right oval key to initialize the card. Press the left oval key to cancel the request and return to INITIALIZE CARD.</p>



Media and Ribbon Sensor Calibration





NOTE: Before you begin this procedure, make sure that the Maximum Length is set to a value equal to or greater than the length of the labels you are using. If the Maximum Length is set to a lower value, the calibration process will assume that continuous media is in the printer. See page 34 for more information.











There are two different types of calibration that can be performed by the printer:







1) Standard Calibration. Pressing the Calibrate key on the printer’s front panel causes the printer to feed media and ribbon and set the values it detects for media, media backing material (the spaces between labels), media out, and ribbon or no ribbon (which determines the print mode—Thermal Transfer or Thermal Direct). This type of calibration also occurs as part of the “Sensor Profile” and “Media and Ribbon Calibrate” procedures specified below.







2) Media and Ribbon Sensor Sensitivity Calibration. Performing the “Media and Ribbon Calibrate” procedure below first resets the sensitivity of the sensors to better detect the media and ribbon you are using. With the sensors at their new sensitivity, the printer then performs the standard calibration described above. Changing the type of ribbon and/or media may require resetting the sensitivity of the Media and Ribbon Sensors. Indications that the sensitivity may need to be reset would be a “Check Ribbon” light on with the ribbon properly installed or non-continuous media being treated as continuous media.









Press	Display Shows	Action/Explanation
	SENSOR PROFILE	<p>Sensor Profile Press Next/Save to skip this standard calibration procedure and continue with “Media and Ribbon Calibrate” parameter which follows.</p> <p>Press the right oval key to initiate this standard calibration procedure and print a Media Sensor Profile.</p> <p>See Figure 10, “Media and Ribbon Sensor Profile Sample Printout,” on page 46.</p> <p>The Media Sensor Profile may be used to troubleshoot registration problems that may be caused when the Media Sensor detects preprinted areas on the media or experiences difficulty in determining web location. If the sensitivity of the Media and/or Ribbon Sensors MUST be adjusted, use the Media and Ribbon Sensor Sensitivity procedure below.</p>
	MEDIA AND RIBBON CALIBRATE	<p>Media and Ribbon Sensor Sensitivity Press Next/Save to skip the calibration procedure shown on the next page and continue with “Setting Host Port” parameter which follows.</p> <p>Press the right oval key to start the calibration procedure.</p> <p>This procedure is used to adjust the sensitivity of the Media and Ribbon Sensors.</p> <p>NOTE: The procedure must be followed exactly as presented on the next page. All steps must be performed even if only one of the sensors requires adjustment.</p>





Media and Ribbon Calibration Procedure		
Press	Display Shows	Action/Explanation
	LOAD BACKING	Press the left oval key to cancel the operation, or do the following: Open the Printhead. Remove as many labels as needed to load a section of blank backing material under the media sensor (just behind the printhead). See Figure 4, "Upper Media Sensor Adjustment," on page 16 to locate the sensor.
	REMOVE RIBBON	Press the left oval key to cancel the operation or do the following: 1) Remove the ribbon (sliding it as far to the right as possible will have the same effect as removing it.) 2) Close the Printhead.
	CALIBRATING PLEASE WAIT	The printer automatically adjusts the scale (gain) of the signals it receives from the media and ribbon sensors based on the specific media and ribbon combination you are using. On the sensor profile, this essentially corresponds to moving the graph up or down to optimize the readings for your application.
----	RELOAD ALL	When "RELOAD ALL" is displayed: 1) Open the Printhead and pull the media forward until a label is positioned under the Media Sensor. 2) Move the ribbon back to its proper position. 3) Close the Printhead.
	MEDIA AND RIBBON CALIBRATE	Now that the scale has changed, the printer performs a calibration equivalent to pressing the Calibrate key. During this process, the printer checks the readings for the media and ribbon based on the new scale you've established, determines the label length, and determines whether you are in thermal direct or thermal transfer print mode. The process is now complete! To see the new readings on the new scale, print a Sensor Profile (see previous page).







Setting Communication Parameters		
Communication parameters must be set correctly for the printer to communicate with the host. These parameters make sure that the printer and host are “speaking the same language”. All communications parameters are password-protected.		
Press	Display Shows	Action/Explanation
	HOST PORT	Setting Host Port  Press the right or left oval key to display other choices. Default: Main RS232. Selections: Main RS232, RS422/485, RS485Multidrop, Parallel Select the communications port that matches the one being used by the host computer.
	BAUD	Setting Baud  Press the right or left oval key to display other choices. Default: 9600 Selections: 110, 300, 600, 1200, 2400, 4800, 9600, 19200, 28800, 57600 The baud setting of the printer must match the baud setting of the host for accurate communications to take place. Select the value that matches the one being used by the host.
	SET DATA BITS	Setting Data Bits  Press the right or left oval key to display other choices. Default: 7-Bits Selections: 7-Bits, 8-Bits The Data Bits of the printer must match the Data Bits of the host for accurate communications to take place. Set the Data Bits to match the setting being used by the host. NOTE: Must be set to 8 data bits to use Code Page 850 or the Twinax or Coax interface options.
	PARITY	Setting Parity  Press the right or left oval key to display other choices. Default: Even Selections: Even, Odd, None The parity of the printer must match the parity of the host for accurate communications to take place. Select the parity that matches the one being used by the host.
	STOP BITS	Setting Stop Bits  Press the right or left oval key to display other choices. Default: 1 Stop Bit Selections: 1 Stop Bit, 2 Stop Bits The stop bits of the printer must match the stop bits of the host for accurate communications to take place. Select the stop bits that match the ones being used by the host.











Press	Display Shows	Action/Explanation
	HOST HANDSHAKE	<p>Setting Host Handshake  Press the right or left oval key to display other choices. Default: XON/XOFF Selections: XON/XOFF, DTR/DSR</p> <p>The handshake protocol of the printer must match the handshake protocol of the host for communications to take place. Select the handshake protocol that matches the one being used by the host.</p>
	PROTOCOL	<p>Setting Protocol  Press the right or left oval key to display other choices. Default: None Selections: None, Zebra, ACK/NACK</p> <p>Protocol is a type of error checking system. Depending on the selection, an indicator may be sent from the printer to the host signifying that data has been received. Select the Protocol that is requested by the host. Further details on Protocol can be found in the ZPL II Programming Guide, available from Zebra Technologies Corporation.</p> <p>NOTE: Zebra is the same as ACK/NACK except that with Zebra the response messages are sequenced. NOTE: If Zebra is selected, printer must use "DTR/DSR" host handshake protocol.</p>
	NETWORK ID	<p>Setting Network ID  Press the left oval key to move to the next digit position, press the right oval key to increase the value of the digit. Default: 000 Range: 000 - 999</p> <p>Network ID is used to assign a unique number to a printer used in a network. This gives the host the means to address a specific printer. If the printer is used in a network, you must select a Network ID number.</p>







Press	Display Shows	Action/Explanation
	COMMUNI- CATIONS	<p>Setting Communications Mode  Press the right or left oval key to display other choices. Default: Normal Mode Selections: Normal Mode, Diagnostics</p> <p>The Communication Diagnostics Mode is a troubleshooting tool for checking the interconnection between the printer and the host. When "Diagnostics" is selected, all data sent from the host to the printer will be printed as straight ASCII hex characters. The printer prints all characters received including control codes, like CR (Carriage Return). A sample printout is shown in Figure 18 on page 69.</p> <p>NOTES on diagnostic printouts:</p> <ul style="list-style-type: none"> • An FE indicates a framing error. • An OE indicates an overrun error. • An PE indicates a parity error. • An NE indicates noise. <p>For any errors, check that your communication parameters are correct. Set the print width equal to or less than the label width used for the test. See page 34 for more information.</p>
<p>Selecting Prefix and Delimiter Characters</p> <p>Prefix and delimiter characters are 2-digit hex values used within the ZPL/ZPL II formats sent to the printer. The printer uses the last prefix and delimiter characters sent to it, whether from a ZPL II instruction or from the front panel.</p> <p>NOTE: To change the values, refer to the ASCII code chart on page 94 for character choices. DO NOT use the same hex value for the Control, Format, and Delimiter character. The printer needs to see different characters to function properly.</p>		
	CONTROL PREFIX	<p>Control Prefix Character  Press the left oval key to move to the next digit position, press the right oval key to increase the value of the digit. Default: 7E (tilde - displayed as a black square) Range: 00-FF (Exclude the values indicated on the ASCII code chart on page 94.)</p> <p>The printer looks for this 2-digit hex character to indicate the start of a ZPL/ZPL II control instruction.</p>
	FORMAT PREFIX	<p>Format Prefix Character  Press the left oval key to move to the next digit position, press the right oval key to increase the value of the digit. Default: 5E (caret) Range: 00 - FF (Exclude the values indicated on the ASCII Code Chart in the Appendix.)</p> <p>The printer looks for this 2-digit hex character to indicate the start of a ZPL/ZPL II format instruction.</p>

Press	Display Shows	Action/Explanation
	DELIMITER CHAR	<p>Delimiter Character  Press the left oval key to move to the next digit position, press the right oval key to increase the value of the digit.</p> <p>Default: 2C (comma) Range: 00 - FF</p> <p>The Delimiter character is a 2-digit hex value used as a parameter place marker in ZPL/ZPL II format instructions. Refer to the ZPL II Programming Guide for more information.</p>
Selecting ZPL Mode		
	ZPL MODE	<p>Selecting ZPL Mode  Press the right or left oval key to display other choices.</p> <p>Default: ZPL II Selections: ZPL II, ZPL</p> <p>The printer will remain in the selected mode until it is changed by this front panel instruction or by using a ZPL/ZPL II command. The printer accepts label formats written in either ZPL or ZPL II. This eliminates the need to rewrite any ZPL formats you already have. Refer to the ZPL II Programming Guide for more information on the differences between ZPL and ZPL II.</p>
Power-Up and Head Close Parameters		
	MEDIA POWER UP	<p>Media Power-Up  Press the right or left oval key to display other choices.</p> <p>Default: Feed Selections: Feed, Calibration, Length, and No Motion</p> <p>This parameter establishes the action of the media when the printer is turned on.</p> <ul style="list-style-type: none"> • Calibration—recalibrates the media and ribbon sensors • Feed—feeds the label to the first web • Length—determines the length of the label • No Motion—media does not move
	HEAD CLOSE	<p>Head Close  Press the right or left oval key to display other choices.</p> <p>Default: Feed Selections: Feed, Calibration, Length, No Motion</p> <p>Determines the action of the media after the printhead has been opened and then closed.</p> <ul style="list-style-type: none"> • Calibration—recalibrates the media and ribbon sensors • Feed—feeds the label to the first web • Length—determines the length of the label • No Motion—media does not move

Label Positioning Parameters		
Press	Display Shows	Action/Explanation
	BACKFEED	<p>Backfeed Sequence  Press the right or left oval key to display other choices. Default: Default ("Default" is defined as 90%) Selections: Default, after, before, 10%, 20%, 30%, 40%, 50%, 60%, 70%, 80%</p> <p>This parameter establishes when and how much label backfeed occurs after a label is removed or cut in the Peel-Off, Cutter, and Applicator modes. It has no effect in Rewind or Tear-Off Modes. This parameter setting can be superseded by the ~JS instruction when received as part of a label format. (Refer to the ZPL II Programming Guide.)</p> <p>NOTE: The difference between the value entered and 100% establishes how much backfeed occurs before the next label is printed. For example, a value of 40 means that 40% of the backfeed takes place after the label is removed or cut. The remaining 60% takes place before the next label is printed. A value of "before" means that all backfeed will take place before the next label is printed.</p>
	LABEL TOP	<p>Adjusting Label Top Position Press the right oval key to increase the value, press the left oval key to decrease the value. The displayed value represents dots. Default: +0 Range: -120 to +120 dot rows</p> <p>The Label Top Position adjusts the print position vertically on the label. Positive numbers adjust the label top position further down the label (away from the printhead), negative numbers adjust the position up the label (toward the printhead).</p>
	LEFT POSITION	<p>Adjusting Left Position Press the left oval key to move to the next position, press the right oval key to change between + and - and to increase the value of the digit. The displayed value represents dots. Default: 0000 Range: -9999 to +9999</p> <p>NOTE: For a negative value, enter the value before changing to the minus sign.</p> <p>This parameter establishes how far from the left edge of a label the format will begin to print by adjusting horizontal positioning on the label. Positive numbers adjust the printing to the left by the number of dots selected, negative numbers shift printing to the right.</p>

Press	Display Shows	Action/Explanation
	HEAD TEST COUNT	<p>Setting the Head Test Count  Press the left oval key to move to the next digit position, press the right oval key to change the value of the digit.</p> <p>Default: 0000 (Disables the test) Range: 0000 to 9999</p> <p>The printer periodically performs a test of the printhead functionality, called a "Printhead Test" or "Head Test". This parameter establishes how many labels are printed between these internal tests.</p>
	HEAD RESISTOR	<p>Setting the Head Resistor Value  Press the left oval key to move to the next digit position, press the right oval key to increase the value of the digit.</p> <p>CAUTION: This parameter should only be changed by qualified personnel!</p> <p>Initial Value: Factory-set to match the printhead shipped with your printer (varries).</p> <p>Default Value: 0500 Range: 0500 - 1175</p> <p>This value has been pre-set at the factory to match the resistance value of the printhead. It will not need to be changed unless...</p> <ol style="list-style-type: none"> 1) The printhead is replaced. 2) The printer is set to the factory defaults. (The factory default value is usually lower than the actual resistance value.) <p>CAUTION: DO NOT set the value higher than that shown on the printhead. Setting a higher value may damage the printhead!</p> <p>Before replacing a printhead, look on the bottom of the printhead element for the label that shows the resistance value (ohm value).</p>
	VERIFIER PORT	<p>Setting the Verifier Port  Press the right or left oval key to display other choices.</p> <p>Default: Off Selections: Off, 1 VER-RPRNT, 2 VER-THRUPUT</p> <p>The Auxiliary Port is used to determine how the printer will react to the Zebra On-Line Verifier. There are currently three operating conditions for this port.</p> <ul style="list-style-type: none"> • Off—The Verifier Port is off. • 1 VER-RPRNT ERR—Label reprinted if verifier detects an error. If a bar code is near the upper edge of the label, the label will be fed out far enough to be verified and then backedf to allow the next label to be printed and verified. • 2 VER-THRUPUT—Allows greatest throughput but may not indicate a verification error immediately upon detection. May print from 1 to 3 labels before an error is recognized and printing stops. <p>For more information on the operation of the optional verifier, refer to the documentation provided with that option.</p>

Press	Display Shows	Action/Explanation
	APPLICATOR PORT	<p>Setting the Applicator Port  Press the right or left oval key to display other choices.</p> <p>Default: Off Selections: Off, Mode 1, Mode 2, Mode 3, Mode 4</p> <p>Determines the action of the verifier port.</p> <ul style="list-style-type: none"> • Off—The applicator port is off. • Mode 1—Asserts the \simEND_PRINT signal low while the printer is moving the label forward. • Mode 2—Asserts the \simEND_PRINT signal high while the printer is moving the label forward. • Mode 3—Asserts the \simEND_PRINT signal low for 20 milliseconds when a label has been completed and positioned. Not asserted during continuous printing modes. • Mode 4—Asserts the \simEND_PRINT signal high for 20 milliseconds when a label has been completed and positioned. Not asserted during continuous printing modes.
	WEB S.	<p>These parameters are automatically set during the calibration procedure. They should only be changed by a qualified service technician. Refer to the maintenance manual for more information on these parameters.</p> <p>Press the Next/Save key repeatedly to skip these parameters.</p>
	MEDIA S.	
	RIBBON S.	
	MARK S.	
	MARK MED S.	
	MEDIA LED	
	RIBBON LED	
	MARK LED	

	LCD ADJUST	<p>LCD Display Adjustment  Press the left oval key to decrease the value (reduce brightness), press the right oval key to increase the value (increase brightness). Range: 00 to 19 This parameter allows you to adjust the brightness of your display if your display is difficult to read.</p>
	LANGUAGE	<p>Selecting the Display Language Press the right or left oval key to display other choices. Default: English Choices: English, Spanish, French, German, Italian This parameter allows you to change the language used on the front panel display.</p>
<p>You have now completed the entire Configuration and Calibration sequence. You may either press the NEXT/SAVE key or the SETUP/EXIT key.</p>		
	DARKNESS	<p>You are now back at the first parameter in the configuration sequence. NOTE: If you pressed the NEXT/SAVE key but are through programming the printer configuration, you may press the SETUP/EXIT key and continue with the Save Settings function.</p>
	SAVE SETTINGS	<p>Save Settings Press the right or left oval key to display other choices. Default: Permanent Choices: Permanent, Temporary, Cancel, Load Defaults, Load Last Save. This display appears when you attempt to exit the configuration mode.</p> <ul style="list-style-type: none"> • Permanent: Permanently saves the changes, even when printer power is turned off. • Temporary: Saves the changes until changed again or until power is turned off. • Cancel: Cancels all changes since you entered the configuration mode except for Darkness and Tear-Off Position (if they were changed). • Load Defaults: Loads factory defaults. NOTE: Loading factory defaults will require Calibration and resetting the Head Resistor value. • Load Last Save: Loads the values from the last permanent save.
	PRINTER READY	<p>Press the Next/Save key to activate the displayed choice. You have exited the Configuration and Calibration Sequence and you are now ready for normal printer operation</p>

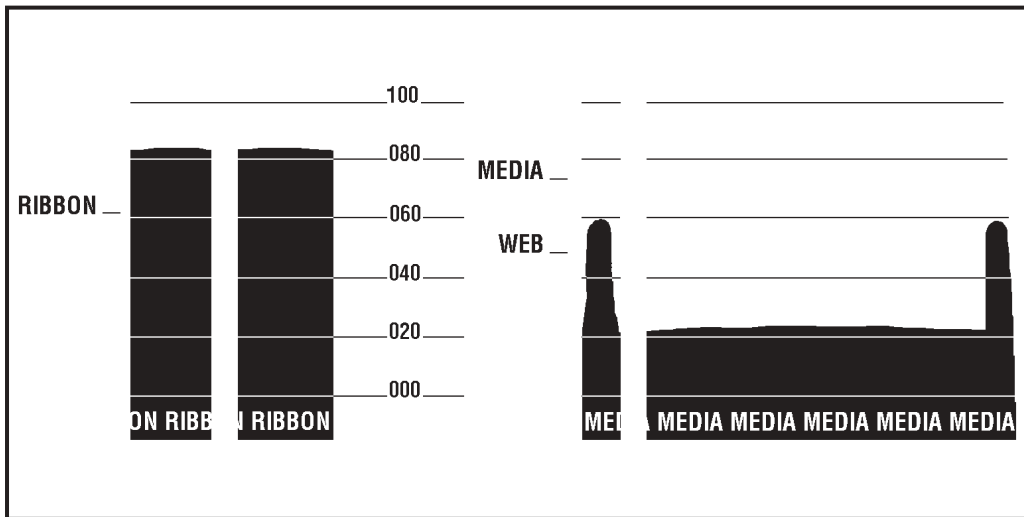

Figure 10. Media and Ribbon Sensor Profile Sample Printout

Sample ZPL II Label Formats

ZPL II[®] is Zebra Technologies Corporation's Zebra Programming Language II label design language. ZPL II lets you create a wide variety of labels from the simple to the very complex, including text, bar codes, and graphics.

This section contains three sample label formats for you to begin experimenting with. It is not intended as an introduction to ZPL II. To learn about ZPL II, send in the request card at the beginning of this book for a free copy of the ZPL II Programming Guide.

For each format, do the following:

1. Set up the printer and turn the power on.
2. Use a text editing program (ex: Windows[™] Write or DOS Editor) and type in the label format exactly as shown in the sample label format below.
3. Save the file in a directory for future use. Use the extension “.zpl”.

4. Copy the file to the Zebra XiII printer.

NOTE: Typically, computers running DOS use the “COPY” command to send a file to the Zebra printer. For example, if your file name is “format1.zpl” then type, “COPY FORMAT 1.ZPL XXXX”, where “XXXX” is the port to which your Zebra printer is connected, for example, “COM1” or “LPT1”.

5. Compare your results with those shown. If your printout does not look like the one shown, confirm that the file you created is identical to the format shown, then repeat the printing procedure. If nothing prints, refer to the “Getting Started” section to make sure your system is set up correctly, otherwise refer to the “Troubleshooting and Diagnostics” section.



Format 1: Simple Text and a Barcode

Line #	Type this label format	You'll get this printout
1.	^XA	ZEBRA 
2.	^LH30,30	
3.	^FO20,10^AD^FDZEBRA^FS	
4.	^FO20,60^B3N,Y,20,N^FDAAA001^FS	
5.	^XZ	
<p>Line #1: Indicates start of label format. Line #2: Sets label home position (in dots) from the upper left-hand corner of the label. Line #3: Sets field origin, selects font "D", defines field data as "ZEBRA". Line #4: Sets field origin, selects bar code Code 39, sets barcode height at 20 dot rows, defines field data for bar code as "AAA001". Line #5: End of label format</p>		

Format 2: Saving a Label Format As a Graphic Image

Line #	Type this label format	You'll get this printout
1.	^XA	Same as Format 1, but this format was also saved in the printer's memory as a graphic image named "FORMAT2". ZEBRA 
2.	^LH30,30	
3.	^FO20,10^AD^FDZEBRA^FS	
4.	^FO20,60^B3N,Y,20,N^FDAAA001^FS	
5.	^ISFORMAT2,N	
6.	^XZ	
7.	^XA	
8.	^ILFORMAT2	
9.	^XZ	
<p>Line #1: Indicates start of label format. Line #2: Sets label home position (in dots) from the upper left-hand corner of the label. Line #3: Sets field origin, selects font "D", defines field data as "ZEBRA". Line #4: Sets field origin, selects bar code Code 39, sets barcode height at 20 dot rows, defines field data for bar code as "AAA001". Line #5: Saves the format in the printer's memory as a graphic image named "FORMAT2:", the "N" indicates "do not print after saving." Line #6-7: (See Format 1) Line #8: Load and print the graphic image saved as "FORMAT2". Line #9: (See Format 1)</p>		

Format 3: Using a Serialized Data Field

Line #	Type this label format	You'll get this printout
1.	^XA	ZEBRA 
2.	^LH30,30	
3.	^FO20,10^AD^FDZEBRA^FS	SERIAL NUMBER 0000000111
4.	^FO20,60^B3,,40,^FDAAA001^FS	Ten labels should print. The first and last are shown here.
5.	^FO20,180^AF^SNSERIAL NUMBER 00000000111,1,Y^FS	ZEBRA 
6.	^PQ10	
7.	^XZ	SERIAL NUMBER 0000000120
Line #1-3: See Format 1) Line #4: Defines field data for bar code as "AAA001". Line #5: Defines serialized field, starting value of 111, increment by 1, insert leading zeros. Line #6: Sets print quantity to 10 Line #7: (See Format 1)		



Routine Care and Adjustment

Cleaning

Table 5 provides a brief cleaning schedule. Specific cleaning procedures are provided on the following pages. A Preventive Maintenance Kit (part # 01429) is available from Zebra. Kit items are also sold separately by the part numbers shown.

Preventive Maintenance Kit

Solvent (Alcohol), 4 oz. bottle (part # 01426)
Applicators, bag of 100 (part # 01427)

Table 5. Cleaning Schedule		
Area	Method	Interval
Printhead	Solvent*	Direct Thermal Print Mode: After every roll of media (or 500 ft. of fanfold media) Thermal Transfer Print Mode: After every roll of ribbon.
Platen Roller	Solvent*	
Transmissive Media Sensor	Air blow	
Reflective (Black-Mark) Media Sensor	Solvent*	
Media Path	Solvent*	
Ribbon Sensor	Air blow	
Peel/Tear Bar	Solvent*	As needed.
Label Available Sensor	Air blow	Monthly.
Cutter Module	Solvent*	As needed.

* Zebra recommends using solvent containing 70% alcohol.

CAUTION: Use only the cleaning agents indicated. Zebra Technologies Corporation will not be responsible for any other fluids being used on this printer.

Cleaning the Exterior

The exterior surfaces of the Zebra XiII-Series printer may be cleaned with a lint-free cloth. Do not use harsh or abrasive cleaning agents or solvents. If necessary, a mild detergent solution or desktop cleaner may be used sparingly.

Cleaning the Interior

Remove any accumulated dirt and lint from the interior of the printer using a soft bristle brush and/or vacuum cleaner. Inspect this area after every four rolls of media.

Cleaning the Printhead and Platen Roller

Inconsistent print quality, such as voids in the bar code or graphics, may indicate a dirty printhead. For best results, perform the following cleaning procedure after every roll of ribbon.

NOTE: You do not need to turn the printer off before cleaning the printhead. If power is turned off, all label formats and images, as well as any temporarily saved parameter settings stored in the printer's internal memory, will be lost. When power is turned back on, you will need to reload these items.

To clean the printhead, refer to Figure 11 and follow these steps:

1. Open the Media Compartment Door.
2. Open the Printhead by moving the Printhead Open Lever to the open position (as shown in Figure 11).
3. Remove the media and ribbon (if present).
4. Moisten an applicator tip with Zebra Technologies Corporation-recommended solvent and wipe along the print elements from end to end. (The print elements are the brown strip just behind the chrome strip on the printhead.) Allow a few seconds for the solvent to evaporate.

5. Rotate the platen roller and clean thoroughly with solvent and an applicator.
6. Brush/vacuum any accumulated paper lint and dust away from the rollers.
7. Reload ribbon and/or media, close and latch the printhead, close the Front Panel and the Media Compartment Door, and continue printing.

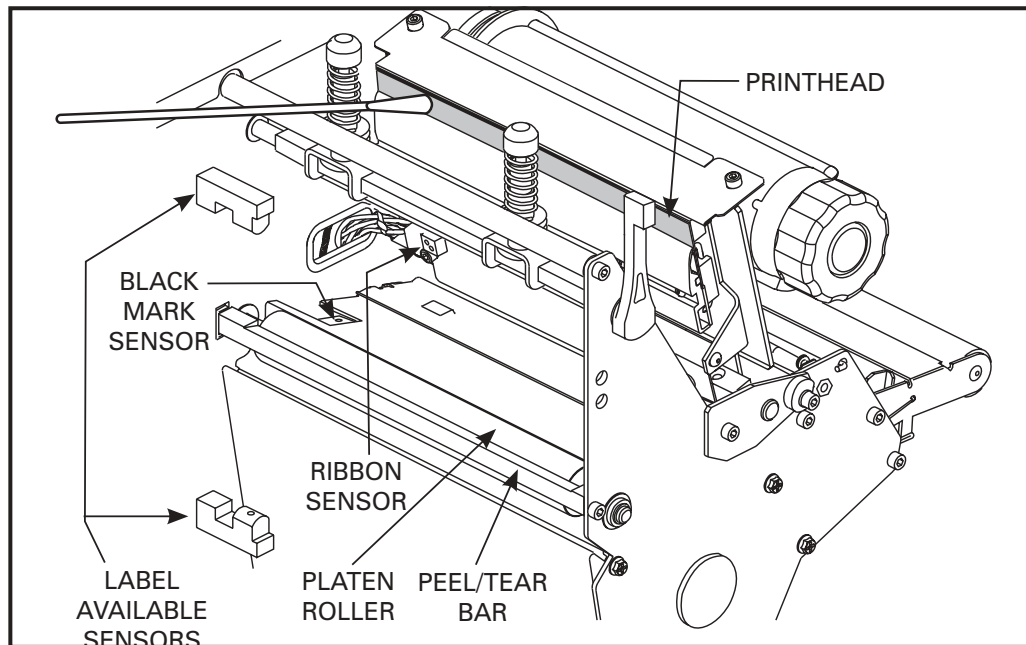

Figure 11. Cleaning Diagram

Cleaning the Sensors

The Media, Ribbon, and Label Available Sensors should be cleaned on a regular basis to ensure proper operation of the printer. To locate the position of these sensors, refer to Figure 11 above, Figure 4 on page 16, and Figure 5 on page 17. Brush/vacuum any accumulated paper lint and dust off of these sensors.

Cleaning the Cutter Module

(For printers equipped with the optional cutter.)

The Cutter Module requires periodic cleaning to remove paper dust and gummed label residue. The procedure should be performed by the operator as needed to ensure proper cutter action. If labels are not being cut properly, or if the cutter jams with labels, this is an indication that the cutter probably needs cleaning. The cleaning frequency depends on your application and media type.

Clean the stationary cutter blade with cleaning solvent when it becomes gummed up with label adhesive and/or paper debris. If further cutter cleaning is necessary, or if the cutter performs unsatisfactorily, contact a service technician.

Lubrication

CAUTION! No lubricating agents of any kind should be used on this printer! Some commercially available lubricants will damage the finish and the mechanical parts if used.

Fuse Replacement

The Zebra XiII printer uses a metric-style fuse (5 X 20 mm IEC) rated at F5A, 250V. The end caps of the fuse must bear the certification mark of a known international safety organization (See Figure 20, “International Safety Organizations,” on page 82). The printer comes with two approved fuses: one in the circuit and one in the “spare fuse” holder.

1. Turn the printer power off and unplug the power cord from the back of the printer. See Figure 12.
2. Using a small-blade screwdriver or similar tool, remove the Fuse Holder from the printer.

3. Remove the faulty fuse and install a new fuse of the correct type. Refer to Figure 13. The fuse that goes into the printer first is the one that is “in-circuit”. If you use the spare fuse, be sure to order a replacement fuse (fuses can be ordered from your Zebra distributor).
4. Snap the Fuse Holder back into position.
5. Reconnect the power cord.

If the new fuse fails right away, the printer has an internal component failure and must be repaired.

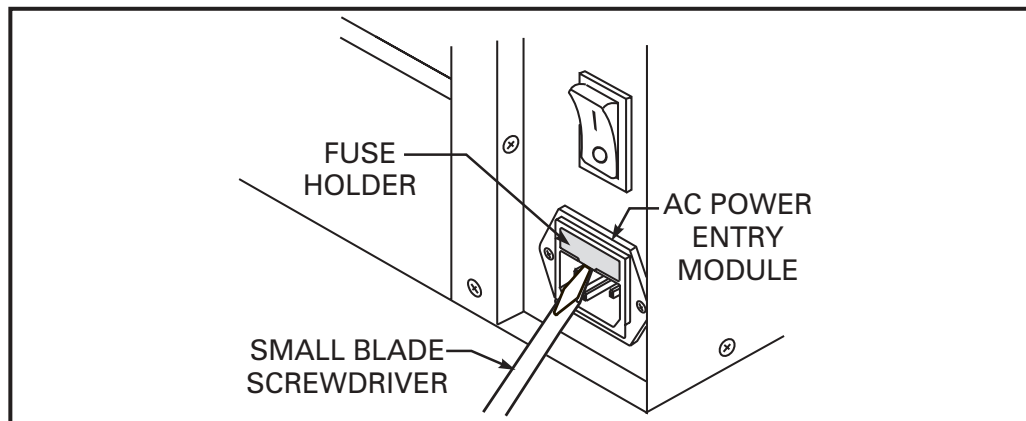

Figure 12. Fuse Replacement—Step 1

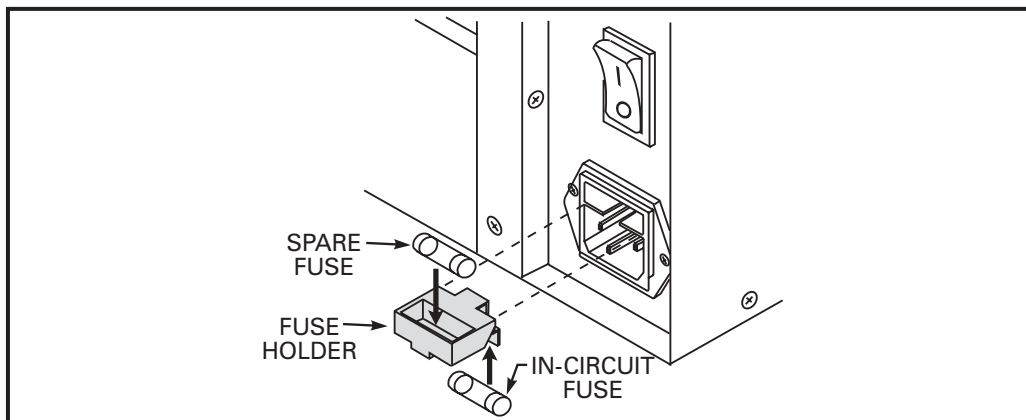

Figure 13. Fuse Replacement—Step 2

Adjustments

Toggle Positioning

Both toggles should be positioned so that they provide even pressure on the media. The toggles are positioned by sliding them to the desired location. On media too narrow to accommodate both toggles, position one toggle over the center of the media and decrease the pressure on the unused toggle.

NOTE: Make sure that the toggle pressure is even across the width of the media, otherwise the media and/or ribbon may drift.

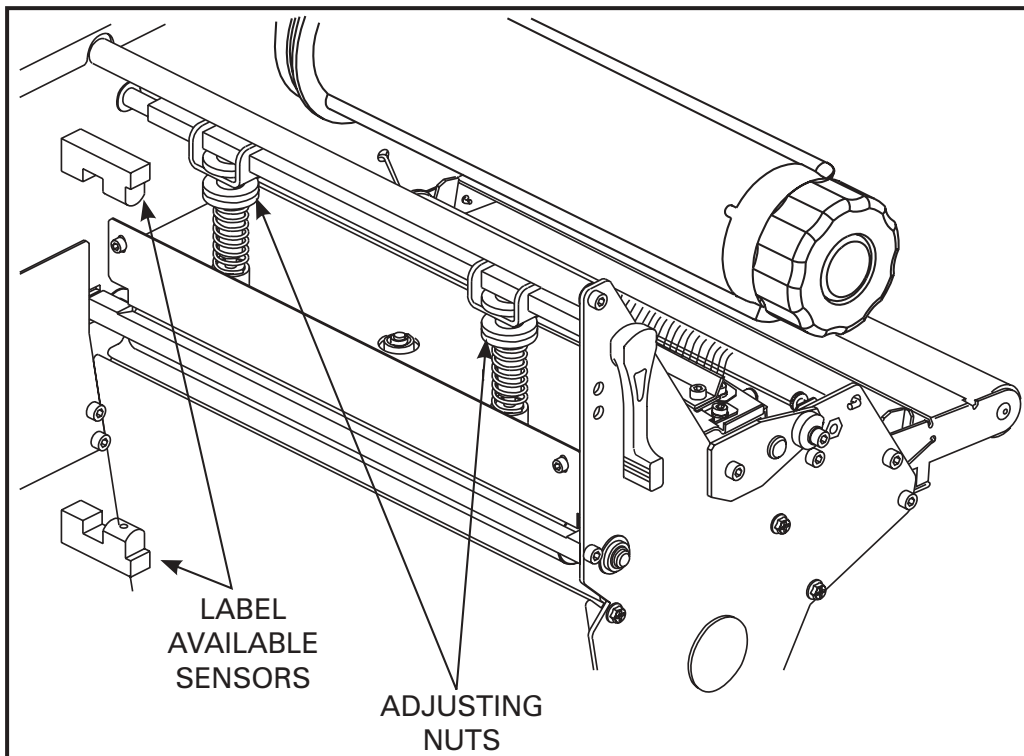

Figure 14. Toggle Adjustment

Printhead Pressure Adjustment

This adjustment may be necessary if printing is too light on one side or if thick media is used. Refer to Figure 14.

1. Perform the Toggle Positioning procedure above. If the problem is solved, you may stop here; otherwise, continue with the rest of this procedure.
2. Print some labels at Speed A, such as by running the Pause Key Self Test (see page 67).
3. While printing labels, lower the Darkness setting until a gray level of printing is seen.
4. Loosen the knurled (upper) locking nuts at the top of the toggle assembly/assemblies.
5. Increase or decrease spring pressure (using the knurled adjustment nuts on the shafts of the toggles) until the left and right edges of printed area are equally dark.

NOTE: Printhead life can be maximized by using the lowest pressure that produces the desired print quality.

6. Increase Darkness to optimum level for the media being used.
7. Retighten locking nuts.

Media Sensor Position Adjustment

See “Transmissive Media Sensor Position Adjustment” on page 15.



Troubleshooting and Diagnostics

This section contains troubleshooting charts used to localize and repair the printer when faults occur. The procedures called out in the “Action” column may be performed by the operator or by a service technician as indicated.

Table 6. Troubleshooting		
Symptom	Diagnosis	Action
All lights light, but nothing appears on the front panel display.	Internal electronic failure.	Call a service technician.
All lights are on but the display screen is not.	Possibility of bad EPROMs (firmware) installed in printer.	Restart printer. If symptom persists call a service technician.
Printer locks up when running the Power-On Self Test.	Normally caused by some hardware failure. Display screen will describe the cause.	Restart printer. If symptom persists call a service technician.
ERROR CONDITION RIBBON OUT Printer stops and Error light flashes.	For thermal transfer mode: Ribbon not loaded or incorrectly loaded. Ribbon Sensor not sensing ribbon that is loaded correctly.	Load ribbon correctly. See “Ribbon Loading” on page 18. Perform the “Media and Ribbon Sensor Calibration” on page 36.
WARNING RIBBON IN Error light flashes.	For direct thermal mode: Ribbon is loaded.	Remove ribbon.
	For thermal transfer mode:	Load ribbon and recalibrate printer. Make sure that the snap plate is in place and clean.

Symptom	Diagnosis	Action
ERROR CONDITION PAPER OUT Printer stops and Error light flashes.	No media loaded or incorrectly loaded.	Reload media. "Rewind Mode Media Loading" on page 11.
	Misadjusted media sensor.	Check position and sensitivity of media sensors.
	Printer set for non-continuous media but continuous media was loaded.	Load proper media or reset printer for current media type.
ERROR CONDITION HEAD OPEN Printer stops and Error light flashes.	Printhead is not fully closed.	Close printhead completely.
	Printhead Resistor value not set correctly.	Set the head resistor value to match the head resistance value printed on the printhead. See page 43.
	Printhead Open sensor not working.	Call a service technician.
WARNING HEAD TOO HOT Printer stops and Error light flashes.	Printhead is overheated.	Allow printer to cool. Printing resumes automatically when the printhead element cools to operating temperature.
	Printhead is dirty.	Clean printhead. See page 52.
	Printhead Resistor value not set correctly.	Set the head resistor value to match the head resistance value printed on the printhead. See page 43.
WARNING HEAD COLD Error light flashes.	Printhead is not hot enough.	Printing continues while printhead heats up. If error remains, environment may be too cold for proper printing. Relocate printer to warmer area.
	Printhead Resistor value not set correctly.	Set the head resistor value to match the head resistance value printed on the printhead. See page 43.

Symptom	Diagnosis	Action
ERROR CONDITION HEAD ELEMENT BAD Experiencing print quality problems.	Printhead element is bad or going bad.	To correct the situation, call a service technician to replace the printhead. To override this error message, place ^JT0 and ~JO in your ZPL II format.
	Printhead Resistor value not set correctly.	Set the head resistor value to match the head resistance value printed on the printhead. See page 43.
WARNING CUTTER JAMMED	Cutter blade in media path.	Turn the power off. Remove the media, reload the media, and turn the power on. If the error condition still exists, call a service technician.
OUT OF MEMORY XXXXXXXXXXXXXXXX Printer stops and PAUSE light is on. "XXXXXXXXXXXXXXXX" can be any of the following messages: <ul style="list-style-type: none"> • Creating bitmap • Storing bitmap • Building format • Storing format • Storing graphic • Storing font 	Not enough memory to perform the function shown on the second line of the error message ("XXXXXXXXXXXXXXXX").	You may do any of the following (A, B, or C): A. (For errors related to storing things) With PAUSE on, use the ~HM ZPL II command to display the amount of free memory. Then... Redesign graphic/format to fit available memory or remove items from memory to create more space. OR Press the Pause key to skip the step in the process and continue on to the next step. B. In Pause Mode, press Cancel. The printer skips the current label formatting process and goes on to the next label. C. Turn the printer power off to clear printer memory and start over.

Symptom	Diagnosis	Action
Long tracks of missing print on several labels.	Wrinkled ribbon.	See "Wrinkled Ribbon" in this table.
	Printhead is dirty.	Clean the printhead. See page 52.
	Print element is damaged.	Call a service technician.
Fine gray lines on blank labels at angles.	Wrinkled ribbon.	See "Wrinkled Ribbon" in this table.
Wrinkled ribbon.	Ribbon fed through machine incorrectly.	See "Ribbon Loading" on page 18.
	Incorrect darkness setting.	Set darkness to the lowest setting possible for good print quality. See "Setting the Darkness" on page 32.
	Incorrect printhead pressure or balance.	Set the pressure to the minimum needed. See "Adjustments" on page 56.
	Media not feeding properly; it is "walking" from side to side.	Make sure that the media is snug by adjusting the Media Guides.
	Strip Plate needs adjusting.	Call a service technician.
	Roller under Printhead needs realigning.	
	Ribbon Supply tension needs adjusting.	
	Printhead Shaft needs adjusting using the Wear Plate.	
	Printhead needs realigning with Platen Roller.	
	Ribbon Take-Up tension needs adjusting to the minimum value.	
Three-point mount for Ribbon Supply Spindle needs adjusting. (Not applicable to the 220XiII printer.)		
Ribbon supply core slipping; spindle blades need adjusting.		

Symptom	Diagnosis	Action
Light vertical lines approximately 0.005" wide running through all labels.	Dirty printhead or ribbon rollers.	Clean the printhead and/or ribbon rollers. See page 52.
Light printing or no printing on the left or right side of the label.	Toggle pressure needs adjustment.	See "Adjustments" on page 56.
	Printhead angle needs adjusting using the Wear Plate adjustment procedure.	Call a service technician.
Short printed lines at 45° to label edge on left or right side of label.	Too much toggle pressure.	Reduce toggle pressure. See "Adjustments" on page 56.
Misregistration and misprint of 1 to 3 labels.	Media was pulled when motor was not moving.	Recalibrate the printer.
	In Rewind or Peel-Off mode: printer was calibrated without media properly installed.	Load media correctly for rewind or peel-off modes. See "Rewind Mode Media Loading" on page 11.
Truncated printing, no printing, or Feed key operates incorrectly while using non-continuous media.	Label format is larger than available memory.	Reduce the size of the format or contact your sales representative for information on memory upgrades.
Label jam in rear area of printhead.	Snap Plate needs cleaning.	Call a service technician.
Missing characters or parts of characters on the front panel display screen.	Display screen may be bad.	Run the Power-On Self Test. If problem persists, call a service technician.
Printed label feeds out and then backfeeds immediately to rest under the printhead.	Printer set for Cutter mode with no Cutter installed.	Set correct print mode. See "Selecting Print Mode" on page 32.
Changes in configuration parameter settings did not take affect.	Parameters are set incorrectly.	Enter the Configuration mode. Set parameters correctly and save permanently. Refer to "Configuration and Calibration".
	If problem continues, there may be a problem with the Main Logic Board.	Call a service technician.

Symptom	Diagnosis	Action
A label format was sent to the printer but not recognized.	Communications parameters are incorrect.	Print a Communications Diagnostic label. Check for Format or Overrun Errors. See "Setting Communication Parameters" on page 38.
	Prefix and delimiter characters set in printer do not match the ones used in the label format.	Set the characters in the printer to match the label format. See "Selecting Prefix and Delimiter Characters" on page 40. If the problem continues, check the ZPL II format for changed ^CC, ^CT, and ^CD commands.
A label format was sent to the printer but not recognized. Data light flashes but no printing occurs.	Communications parameters are incorrect.	Print a Communications Diagnostic label. Check for Format or Overrun Errors. See "Setting Communication Parameters" on page 38.
	Prefix and delimiter characters set in printer do not match the ones used in the label format.	Set the characters in the printer to match the label format. See "Selecting Prefix and Delimiter Characters" on page 40. If the problem continues, check the ZPL II format for changed ^CC, ^CT, and ^CD commands.
A batch of labels was sent. Several labels print then printer skips, misplaces, misses, or distorts the printing on the labels.	Buffer is overfilling.	Check for proper flow control setting. Refer to "Configuration and Calibration".

Printer Diagnostics

Power-On Self Test

A Power-On Self Test (POST) is performed automatically each time the printer is turned on. This test checks for proper initialization of various electronic circuits and establishes starting parameters as those stored in the printer's memory. During this test sequence, the front panel lights turn on and off to ensure proper operation. See "Power-On Self Test Sequence" on page 28.

Additional Printer Self Tests

These self tests produce sample printouts and provide specific information which helps determine the operating conditions for the printer.

Each self test is enabled by pressing a specific Front Panel key or combination of keys while turning the Power Switch on. Keep the key depressed until the Data light turns off. When the Power-On Self Test is complete, the selected self test starts automatically.

NOTES: When performing self tests, disconnect all data interface cables from the printer.

When canceling a self test prior to its actual completion, always turn the printer power off and then back on to reset the printer.

When performing these self tests while in the Peel-Off Mode, you must remove the labels as they become available.

If your media is not wide enough or long enough, unexpected and/or undesired results may occur. Make sure that your print width is set correctly for the media you are using before you run any self tests, otherwise the test may print out on the platen. See page 34 for information on setting the print width.

Cancel Key Self Test

Turn the printer off. Press the Cancel Key and hold while turning the power on. This self test prints a listing of the configuration parameters currently stored in the printer's memory. See Figure 15.

The configuration may be changed either temporarily (for specific label formats or ribbon and label stock), or permanently (by saving the new parameters in memory.) Saving new parameters occurs whenever a Calibration procedure is performed. Refer to page 29 for further information about the Configuration procedure.

```

          PRINTER CONFIGURATION
+10..... DARKNESS
-8..... TEAR OFF
CUTTER..... PRINT MODE
NON-CONTINUOUS..... MEDIA TYPE
WEB..... SENSOR TYPE
THERMAL-TRANS..... PRINT METHOD
128 0/8 MM..... PRINT WIDTH
1237..... LABEL LENGTH
39.0IN 968MM..... MAXIMUM LENGTH
MAIN RS232..... HOST PORT
19200..... BAUD
8 BITS..... DATA BITS
NONE..... PARITY
1 STOP BIT..... STOP BITS
XON/XOFF..... HOST HANDSHAKE
NONE..... PROTOCOL
000..... NETWORK ID
NORMAL MODE..... COMMUNICATIONS
< > 7EH..... CONTROL PREFIX
< > 5EH..... FORMAT PREFIX
< , > 2CH..... DELIMITER CHAR
ZPL II..... ZPL MODE
FEED..... MEDIA POWER UP
FEED..... HEAD CLOSE
DEFAULT..... BACKFEED
+000..... LABEL TOP
+0000..... LEFT POSITION
0000..... HEAD TEST COUNT
0500..... HEAD RESISTOR
OFF..... VERIFIER PORT
OFF..... APPLICATOR PORT
038..... WEB S.
075..... MEDIA S.
071..... RIBBON S.
000..... MARK S.
000..... MARK MED S.
015..... MEDIA LED
018..... RIBBON LED
019..... MARK LED
+12..... LCD ADJUST
DPCSWFXM..... MODES ENABLED
..... MODES DISABLED
1024 8/MM FULL..... RESOLUTION
..... SOCKET 1 ID
VXX.X.X <-..... FIRMWARE
CUSTOMIZED..... CONFIGURATION
1024k..... MEMORY
INSTALLED..... B: MEMORY
004 DISPLAY..... J12 INTERFACE
004 POWER SUPPLY..... J11 INTERFACE
*** CUTTER..... J10 INTERFACE
*** NONE..... J9 INTERFACE
*** NONE..... J8 INTERFACE
*** NONE..... J7 INTERFACE
FIRMWARE IN THIS PRINTER IS COPYRIGHTED
```

Figure 15. Cancel Key Self Test Sample Printout



Figure 16. Pause Key Self Test Sample Printout

Pause Key Self Test

This self test can be used to provide the test labels required when making adjustments to the printer's mechanical assemblies. See the sample printout in Figure 16.

Turn the printer off. Press the Pause key and hold while turning the power on.

1. The initial self test prints 15 labels at speed "A" (2.4" per second) then automatically pauses the printer. Each time the Pause key is pressed, an additional 15 labels print.
2. While the printer is paused, pressing the Cancel key alters the self test. Now each time the Pause key is pressed the printer prints 15 labels at speed "D" (6" per second).
3. While the printer is paused, pressing the Cancel key again alters the self test again. Now each time the Pause key is pressed the printer prints 50 labels at speed "A".
4. While the printer is paused, pressing the Cancel key again alters the self test a third time. Now each time the Pause key is pressed the printer prints 50 labels at speed "D".
5. While the printer is paused, pressing the Cancel key again alters the self test a fourth time. Now each time the Pause key is pressed the printer prints 15 labels at 12" per second.

Feed Key Self Test

The Cancel Key Self Test should be performed prior to this self test. Information on the “Configuration” printout (Cancel Key Self Test) can be used with the results of this self test to determine the best Darkness setting for a specific media/ribbon combination.

The Feed Key Self Test will print out at various Darkness settings above and below that of the Darkness value shown on the Configuration Label. See Figure 17. Inspect these labels and determine which one has the best darkness setting for the application. This value can be entered into the printer by setting the Darkness during the configuration procedure. Refer to page 32 for more information.

The value printed on that label is added to (plus) or subtracted from (minus) the “Darkness” value specified on the Configuration Label. The resulting numeric value (0 to 30) is the best darkness value for that specific media/ribbon combination.

Feed Key and Pause Key Self Test

Pressing these two keys at the same time, while turning the Power on, temporarily resets the Printer Configuration to the factory default values. These values will be active only until power is turned off unless you save them permanently in memory.

Communications Diagnostics Test

This test is controlled from the front panel display. Refer to page 40. A typical printout from this test is shown in Figure 18. Turn the power off to exit this self test.

NOTE: This label will be inverted when printed.

Additional Printer Diagnostics

Additional diagnostic tests are available for the Zebra XiII printer, however they are beyond the scope of this user’s guide. Refer to the maintenance manual (part # 48452L) for information about these additional tests.



Figure 17. Feed Key Test Sample Printout

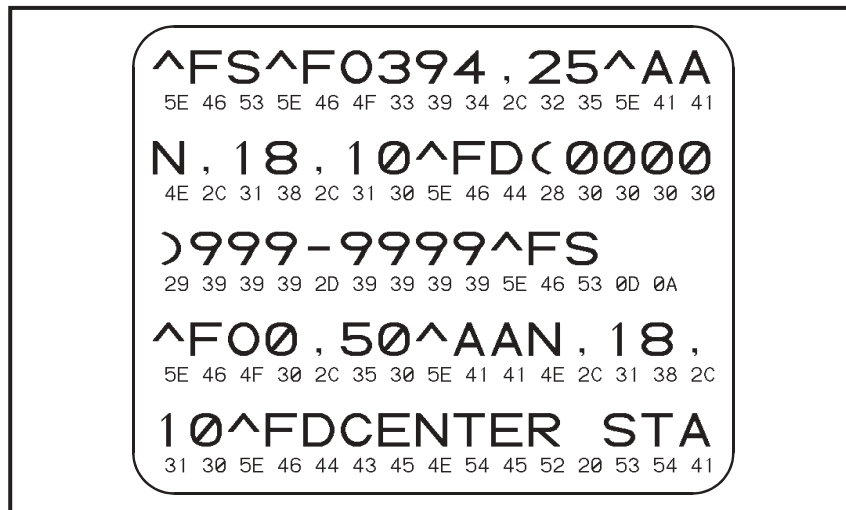

Figure 18. Communications Diagnostics Test Sample Printout



Options

NOTE: Your printer may not have all of the options described in this chapter. Call your sales representative for more information about these options.

Rewind Option

Your Zebra XiII-Series printer may be equipped with the optional Media Rewind capability required for Rewind and Peel-Off modes of operation.

In Rewind Mode, both labels and backing material rewind internally onto a 3-inch core. A Rewind Bracket guides the media back to the Rewind Spindle after printing.

In Peel-off Mode, only the backing rewinds onto the Rewind Spindle. The Peel/Tear Bar separates the label from the backing and the Label Available Sensor activates to allow the operator to remove a printed label before subsequent labels print. Select either the Rewind or Peel-off Print Mode from the front panel display.

Cutter

Your Zebra XiII printer may be equipped with a cutter used to cut the labels after they are printed. The Cutter Option may be installed concurrently with other options including the Rewind Option. The Cutter Option may be factory-installed or it may be installed in the field by a qualified service technician.

The Cutter Option must be enabled by entering the Programming Mode and using the front panel display to select the Cutter Print Mode. Refer to the “Operation” section for additional information. The Cutter Catch Tray may be installed to collect labels, tickets, or tags after being cut.

Internal Fanfold Media Supply Bin

Your Zebra XiII-Series printer may be equipped with an optional internal Fanfold Media Supply Bin. It is used to load fanfold media within the XiII printer's media compartment, and protects the media from environmental contaminants such as dust and dirt. The Fanfold Media Supply Bin may be installed in the field by the operator.

NOTE: The Fanfold Media Supply Bin may not be installed in XiII printers with the Rewind Option. Fanfold media may be used on printers with the Rewind Option installed by using one of the external fanfold supply access slots at the bottom and rear of the printer.

Memory SIMMs

Memory SIMMs increase the graphics storage capacity of the printer, increase the maximum print length, and/or increase through-put by increasing format-while-print abilities. Contact your sales representative to purchase compatible SIMMs in 1, 2, 4, and 8 MB sizes.

On-Line Verifier

The On-Line Verifier is an external device that provides the means to automatically scan and analyze certain bar code symbols as they are printed. If the verifier detects a problem with the bar code, it will automatically pause the printer. The operator must then correct the problem and take the printer out of pause mode before printing will resume.

Several operational modes are available, ranging from simple freescan to one where specific symbology and data is required.

Applicator Interface

The Applicator Interface is an ideal method of integrating XiII printers into custom applications. This interface allows printer control from a personal computer or Programmable Logic Controller (PLC) via one cable attached to a connector located at the rear of the printer. This provides the capability of placing the XiII printers on a production line in a loose loop, print and apply configuration, or other applications where the printer must be controlled by a machine.

Media Supply Spindle

The optional Media Supply Spindle replaces the standard hanger. This is useful for applications that require the printer to be mounted in a non-horizontal position where the standard media hanger prohibits consistent media flow.

Optional Media Supply Fins

Optional Media Supply Fins are available to convert the standard 3-inch (76 mm) core diameter to a 1.77 inch (45 mm) core for smaller core media rolls. Simply remove the current fins and install the reduced-diameter fins.

Fonts

There is a wide range of optional character fonts that can be purchased for your XiII printer in addition to those fonts which are standard in the unit. Fonts may be purchased on EPROMs or on PCMCIA cards, depending on your needs.

Refer to “Optional Printer Fonts” on page 85 for information about optional fonts. From time to time, additions may be made to the list of available fonts. Contact your sales representative for further information.

PCMCIA Type I Memory Cards

These memory cards work with the XiII printer's standard memory card interface. With these cards, users can store complete label formats, images/graphics, and fonts for easy transfer to the printer's memory. Storing data on PCMCIA cards minimizes download time and maximizes throughput. Contact your sales representative to purchase compatible cards.

KMT Printhead

The KMT printhead, used on all older printers, is available for use with the XiII printers for customers who want to maintain full compatibility with their existing printers.

Communication Interfaces

IBM® Twinax Interface

This interface emulates IBM® System 3/X and AS/400 (5224, 5225, 5256, and 4214) printers. This option comes with an auto-terminating 1 ft. Y-connector cable.

IBM® Coax Interface

This interface emulates an IBM® System 3287 printer used in the IBM 3270 environment. This option comes with a BNC connector to interface to your host mainframe's controller.

ZebraNet™ (Ethernet) Interface

The ZebraNet™ Micro Print Server (MPS) provides ethernet connectivity for your Zebra printer. The ZebraNet MPS is a multiprotocol print server. It provides shared network access to a Zebra printer for a variety of network protocols and operating systems. The MPS1-T provides a twisted pair (10Base-T) connector for network connections and a parallel Centronics®

port to which network nodes can spool print jobs. The MPS1-2 provides a thinwire (10Base-2) connector and a parallel port for the same purposes. Both servers can queue multiple pending jobs and service those jobs in the order in which they are received from the hosts.

RS-485 Interface

The RS-485 interface provides a simple and cost-effective way to connect a PC and multiple printers together to create an instant network. This simple cabling system connects directly to a personal computer's serial port and allows multiple hook-ups—perfect for anyone who wants to connect several printers to a single host.



Specifications

NOTE: Your printer may not have all of the options described in this chapter.

Media Handling

- Tear-Off mode: labels are produced in strips
- Peel-Off mode: labels are dispensed and peeled from the liner as needed
- Cutter mode: labels are printed and individually cut
- Rewind mode: labels are rewound internally
- Applicator mode: labels are peeled from the liner and presented for use by an external applicator device

Options

- IBM Twinax Interface
- IBM Coax Interface
- ZebraNet™—Ethernet Interface:
10Base-T and 10Base-2
- RS-485 Interface
- Font Cards
- Font EPROMs
- Memory Expandable to 2, 3, 5, or 9 MB
- Memory Cards
- KMT Printhead (not applicable to the 220XiII printer)
- Programmable Print Speeds from 2.4" (61 mm) to 8" (203 mm) per second
- Printer Drivers for Windows™ 3.X and Windows 95 Operating Systems
- Cutter
- Rewind
- Cutter-Rewind
- Cutter Tray
- Media Supply Spindle
- Clear Media Supply Door
- Applicator Interface
- On-Line Bar Code Verifier
- Internal Fanfold Media Supply Bin
- PC-470 Print Controller with Keyboard and Display for Stand-Alone Applications
- Bar-One® Windows™-Based WYSIWYG On-Screen Label Design and Print Application Software

Zebra Programming language (ZPL II®)

- Downloadable graphics, scalable and bitmap fonts, and label formats
- Object copying between memory areas (RAM and memory card)
- Code Page 850 character set
- Adjustable print cache
- Data compression
- Automatic virtual input buffer management
- Automatic memory allocation
- Format inversion
- Mirror image printing
- Four-position field rotation (0°, 90°, 180°, and 270°)
- Slew command
- Programmable quantity with print, pause, and cut control
- Communicates in printable ASCII characters
- Error-checking protocol
- Controlled via mainframe, mini-computer, PC, portable data terminal
- Serialized fields
- In-spec OCR-A and OCR-B
- UPC/EAN
- User-programmable password
- Status message to host upon request

Bar Codes

- Bar code ratios - 2:1, 7:3, 5:2, & 3:1
- Code 11
- Code 39 (Supports ratios of 2:1 up to 3:1)
- Code 49 (2-dimensional bar code)
- Code 93
- Code 128 (With subsets A, B, and C and UCC Case C Codes)
- Codabar (Supports ratios of 2:1 up to 3:1)
- CODABLOCK
- Interleaved 2 of 5 (Supports ratios of 2:1 up to 3:1, Modulus 10 Check Digit)
- Industrial 2 of 5
- Standard 2 of 5
- ISBT-128
- LOGMARS
- Plessey
- EAN-8, EAN-13, EAN EXTENSIONS
- UPC-A, UPC-E, UPC EXTENSIONS
- MSI
- PDF-417 (2-dimensional bar code)
- POSTNET
- MaxiCode
- Data Matrix
- Check digit calculation where applicable

General Specifications

General Specifications			90XiII		140XiII		170XiII		220XiII	
Height			15.5"	393.7 mm	15.5"	393.7 mm	15.5"	393.7 mm	15.5"	393.7 mm
Width			9.15"	232.4 mm	11.2"	285.7 mm	13.15"	334.4 mm	15.65"	397.5 mm
Depth			19.5"	495.3 mm	19.5"	495.3 mm	19.5"	495.3 mm	19.5"	495.3 mm
Weight (without options)			50 lb	23 kg	55 lb	25 kg	67 lb	30.5 kg	72 lb	32.7 kg
Electrical	General		90-264 VAC; 48-62 Hz		90-264 VAC; 48-62 Hz		90-264 VAC; 48-62 Hz		90-264 VAC; 48-62 Hz	
	Power Consumption	Printing Pause Test label at speed "A"	121 W		180 W		220 W		269 W	
		Printer idle	20 W		19 W		19 W		20 W	
	Compliance		Complies with FCC class "A" and Canadian Doc. class "A" rules. Carries the CE mark of compliance.							
Temperature	Operating Environment	Thermal Transfer	41° to 104° F	5° to 40° C	41° to 104° F	5° to 40° C	41° to 104° F	5° to 40° C	41° to 104° F	5° to 40° C
		Direct Thermal	32° to 104° F	0° to 40° C	32° to 104° F	0° to 40° C	32° to 104° F	0° to 40° C	32° to 104° F	0° to 40° C
	Storage		-40° to 140° F	-40° to 60° C	-40° to 140° F	-40° to 60° C	-40° to 140° F	-40° to 60° C	-40° to 140° F	-40° to 60° C
Relative Humidity	Operating Environment		20 to 85% non-condensing		20 to 85% non-condensing		20 to 85% non-condensing		20 to 85% non-condensing	
	Storage		5 to 85% non-condensing		5 to 85% non-condensing		5 to 85% non-condensing		5 to 85% non-condensing	

Printing Specifications

Printing Specifications		90Xill	140Xill	170Xill	220Xill	
Resolution		300 dots/inch (12 dots/mm)	203 dots/inch (8 dots/mm)	300 dots/inch (12 dots/mm)	203 dots/inch (8 dots/mm)	
Dot size (Width x Length)		0.0033" x 0.0039" (.084 x .100 mm)	0.0049" x 0.0049" (.125 x .125 mm)	0.0033" x 0.0039" (.085 x .100 mm)	0.0049" x 0.0049" (.125 x .125 mm)	
First dot location from inside media edge		0.12" ± .035" (3 mm ± .89 mm)	0.10" ± .035" (2.5 mm ± .89 mm)	0.10" ± .035" (2.5 mm ± .89 mm)	0.10" ± .035" (2.5 mm ± .89 mm)	
Maximum print width		3.4" (86 mm)	5.04" (128 mm)	6.6" (168 mm)	8.5" (216 mm)	
Print length (Maximum)	Non-continuous printing	With standard memory	20" (508 mm)	30" (762 mm)	10" (254 mm)	16" (406 mm)
		With 9 MB memory	39" (991 mm)	39" (991 mm)	39" (991 mm)	39" (991 mm)
	Continuous printing	With standard memory	20" (508 mm)	30" (762 mm)	10" (254 mm)	18" (457 mm)
		With 9 MB memory	100" (2540 mm)	150" (3810 mm)	100" (2540 mm)	150" (3810 mm)
Bar code modulus ("X") dimension	Ladder (Rotated) orientation	3.9 mil to 39 mil	4.9 mil to 49 mil	3.9 mil to 39 mil	4.9 mil to 49 mil	
	Picket Fence (Non-rotated)	3.33 mil to 33 mil	4.9 mil to 49 mil	3.33 mil to 33 mil	4.9 mil to 49 mil	
Thin-film printhead with Element Energy Equalizer (E3) [®]		Yes	Yes	Yes	Yes	

Ribbon Specification

Ribbon Specifications		90Xill	140Xill	170Xill	220Xill
Ribbon must be wound with the coated side out.					
Ribbon Width (Zebra recom- mends using ribbon at least as wide as the media to protect the printhead from wear.)	Minimum	0.79" (20 mm)	1.57" (40 mm)	2.0" (51 mm)	4.25" (108 mm)
	Maximum	3.40" (87 mm)	5.10" (130 mm)	6.7" (170 mm)	8.60" (220 mm)
Standard lengths	2:1 media to ribbon roll ratio	984 ft. (300 m)	984 ft. (300 m)	984 ft. (300 m)	984 ft. (300 m)
	3:1 media to ribbon roll ratio	1476 ft. (450 m)	1476 ft. (450 m)	1476 ft. (450 m)	1476 ft. (450 m)
Ribbon core inside diameter		1.0" (25.4 mm)	1.0" (25.4 mm)	1.0" (25.4 mm)	1.0" (25.4 mm)
Maximum ribbon roll outside diameter		3.2" (81.3 mm)	3.2" (81.3 mm)	3.2" (81.3 mm)	3.2" (81.3 mm)

Media Specifications

Media Specifications		90Xill	140Xill	170Xill	220Xill	
Minimum label length *	Tear-Off	0.7" (18 mm)	0.7" (18 mm)	0.7" (18 mm)	0.7" (18 mm)	
	Peel-Off	0.5" (13 mm)	0.5" (13 mm)	0.5" (13 mm)	0.5" (13 mm)	
	Cutter	1.5" (38 mm)	1.5" (38 mm)	1.5" (38 mm)	1.5" (38 mm)	
	Rewind	0.25" (6 mm)	0.25" (6 mm)	0.25" (6 mm)	0.25" (6 mm)	
Total media width (label + liner, if any)	Minimum	0.79" (20 mm)	1.57" (40 mm)	2.00" (50.8 mm)	4.25" (108 mm)	
	Maximum	3.54" (90 mm)	5.51" (140 mm)	7.17" (182 mm)	8.80" (224 mm)	
Total thickness (includes liner, if any)	Minimum	0.003" (0.076 mm)	0.003" (0.076 mm)	0.003" (0.076 mm)	0.003" (0.076 mm)	
	Maximum	0.012" (0.305 mm)	0.012" (0.305 mm)	0.012" (0.305 mm)	0.012" (0.305 mm)	
Cutter maximum full-width media thickness		.014" (.35 mm)	.009" (.23 mm)	.007" (.18 mm)	.005" (.14 mm)	
Roll media core inside diameter		3" (76 mm)	3" (76 mm)	3" (76 mm)	3" (76 mm)	
Maximum roll diameter		8.0" (203 mm)	8.0" (203 mm)	8.0" (203 mm)	8.0" (203 mm)	
Inter-label gap	Minimum	0.079" (2 mm)	0.079" (2 mm)	0.079" (2 mm)	0.079" (2 mm)	
	Preferred	0.118" (3 mm)	0.118" (3 mm)	0.118" (3 mm)	0.118" (3 mm)	
	Maximum	Maximum Inter-label gap = 2 x (label length for which you have calibrated the printer) + 1"				
Maximum internal fanfold media pack size (label + liner) L x W x H		8.0" x 3.54" x 4.5" (203x90x114 mm)	8.0" x 5.51" x 4.5" (203x140x114 mm)	8.0" x 7.1" x 4.5" (203x180x114 mm)	8.0" x 8.8" x 4.5" (203x224x114 mm)	
Ticket/tag sensing notch L x W		0.12" x .25" (3 mm) x (6 mm)	0.12" x .25" (3 mm) x (6 mm)	0.12" x .25" (3 mm) x (6 mm)	0.12" x .25" (3 mm) x (6 mm)	
Ticket/tag sensing hole diameter		0.125" (3 mm)	0.125" (3 mm)	0.125" (3 mm)	0.125" (3 mm)	
Effective leading edge registration accuracy *	Vertical	±0.060" (±1.5 mm)	±0.070" (±1.8 mm)	±0.060" (±1.5 mm)	±0.050" (±1.3 mm)	
	Horizontal	±0.060" (±1.5 mm)	±0.070" (±1.8 mm)	±0.060" (±1.5 mm)	±0.060" (±1.5 mm)	
Additional specs. for black mark sensing	Mark length (measuring parallel to label/tag edge)	Minimum	0.12" (3 mm)	0.12" (3 mm)	0.12" (3 mm)	0.12" (3 mm)
		Maximum	0.43" (11 mm)	0.43" (11 mm)	0.43" (11 mm)	0.43" (11 mm)
	Mark width (measuring perpendicular to label/tag edge)	Minimum	0.43" (11 mm)	0.43" (11 mm)	0.43" (11 mm)	0.43" (11 mm)
		Maximum	Full media width	Full media width	Full media width	Full media width
	Mark location		Marks must be located within .040" (1 mm) of the inside media edge.			
	Mark density		> 1.0 ODU (Optical DensityUnit)	> 1.0 ODU (Optical DensityUnit)	> 1.0 ODU (Optical DensityUnit)	> 1.0 ODU (Optical DensityUnit)
Maximum density of the back of the media on which the black mark is printed		0.5 ODU	0.5 ODU	0.5 ODU	0.5 ODU	

* Media registration and minimum label length are affected by media type and width, ribbon type, print speed, and printer mode of operation. Performance improves as these factors are optimized. Zebra recommends always qualifying any application with thorough testing.

Power Line Cord Specifications

- The overall length must be less than 9.8 ft. (3.0 meters)
- It must be rated for at least 5 A, 250 V.
- The chassis ground (earth) **MUST** be connected to assure safety and reduce electromagnetic interference. The ground connection is handled by the third wire (earth) in the power line cord. See Figure 19.
- The AC power plug and IEC 320 connector must bear the certification mark of at least one of the known international safety organizations shown in Figure 20.

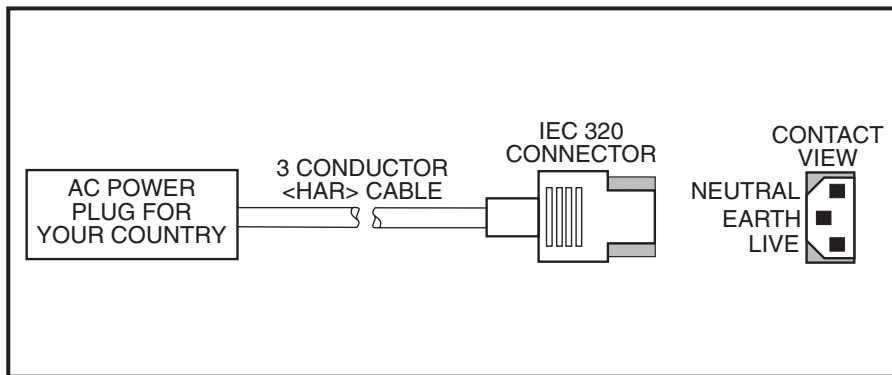

Figure 19. Power Line Cord

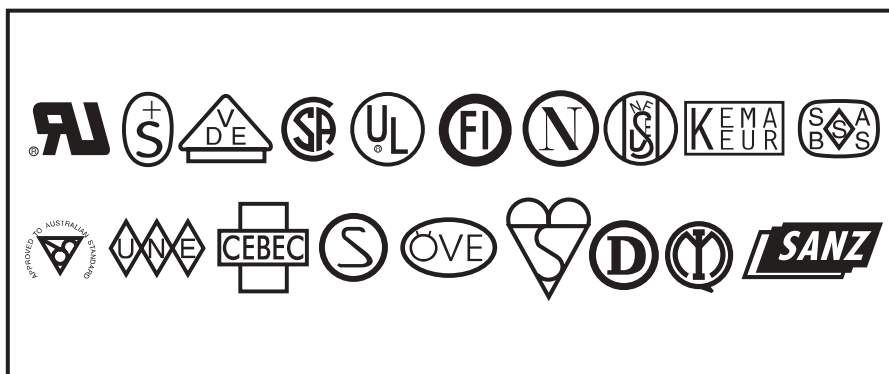

Figure 20. International Safety Organizations

Printer Fonts

Standard Printer Fonts

For more information on fonts, refer to the ZPL II Programming Guide.

- Bit-mapped fonts A, B, C, D, E, F, G, H, and GS are expandable up to 10 times, height- and width-independent. However, fonts E and H (OCR-B and OCR-A) are not considered in-spec when expanded.
- The scalable (smooth) font (CG Triumvirate™ Bold Condensed) is expandable on a dot-by-dot basis, height- and width-independent, while maintaining smooth edges, to a maximum of 1500 x 1500 dots.
- IBM Code Page 850 international characters are available in fonts A, B, C, D, E, F, G, and Ø through software control.

Table 7. Eight Dots/mm Printhead					
Standard Fonts	Dot Matrix		Type U = Uppercase L = Lowercase D = Descenders	Minimum Character Size	
	Height x Width (in dots)	Inter-character Gap		Height x Width	Character Density
A	9 x 5	1	U-L-D	0.044" x 0.029" 1.13 mm x 0.75 mm	33.90 Char/inch 1.33 Char/mm
B	11 x 7	2	U	0.054" x 0.044" 1.38 mm x 1.13 mm	22.60 Char/inch 0.89 Char/mm
C, D	18 x 10	2	U-L-D	0.088" x 0.059" 2.25 mm x 1.50 mm	16.95 Char/inch 0.67 Char/mm
E	28 x 15	5	OCR-B	0.138" x 0.098" 3.50 mm x 2.50 mm	10.17 Char/inch 0.40 Char/mm
F	26 x 13	3	U-L-D	0.128" x 0.079" 3.25 mm x 2.00 mm	12.71 Char/inch 0.50 Char/mm
G	60 x 40	8	U-L-D	0.295" x 0.236" 7.50 mm x 6.00 mm	4.24 Char/inch 0.17 Char/mm
H	21 x 13	6	OCR-A	0.103" x 0.093" 2.63 mm x 2.38 mm	10.71 Char/inch 0.42 Char/mm
GS	24 x 24	0	SYMBOL	0.118" x 0.118" 3.00 mm x 3.00 mm	8.48 Char/inch 0.33 Char/mm
Ø	Default: 15 x 12		U-L-D	Scalable (smooth) font	

Table 8. Twelve Dots/mm Printhead					
Standard Fonts	Dot Matrix		Type	Minimum Character Size	
	Height x Width (in dots)	Inter-character Gap	U = Uppercase L = Lowercase D = Descenders	Height x Width	Character Density
A	9 x 5	1	U-L-D	0.030" x 0.020" 0.76 mm x 0.51 mm	50.00 Char/inch 1.97 Char/mm
B	11 x 7	2	U	0.037" x 0.030" 0.93 mm x 0.76 mm	33.33 Char/inch 1.31 Char/mm
C, D	18 x 10	2	U-L-D	0.060" x 0.040" 1.53 mm x 1.02 mm	25.00 Char/inch 0.98 Char/mm
E	41 x 20	6	OCR-B	0.137" x 0.087" 3.47 mm x 2.20 mm	11.54 Char/inch 0.45 Char/mm
F	26 x 13	3	U-L-D	0.087" x 0.053" 2.20 mm x 1.36 mm	18.75 Char/inch 0.74 Char/mm
G	60 x 40	8	U-L-D	0.200" x 0.160" 5.08 mm x 4.07 mm	6.25 Char/inch 0.25 Char/mm
H	30 x 19	9	OCR-A	0.100" x 0.093" 2.54 mm x 2.37 mm	10.71 Char/inch 0.42 Char/mm
GS	24 x 24	0	SYMBOL	0.080" x 0.080" 2.03 mm x 2.03 mm	12.50 Char/inch 0.49 Char/mm
∅	Default: 15 x 12		U-L-D	Scalable (smooth) font	

Standard Printer Font Examples

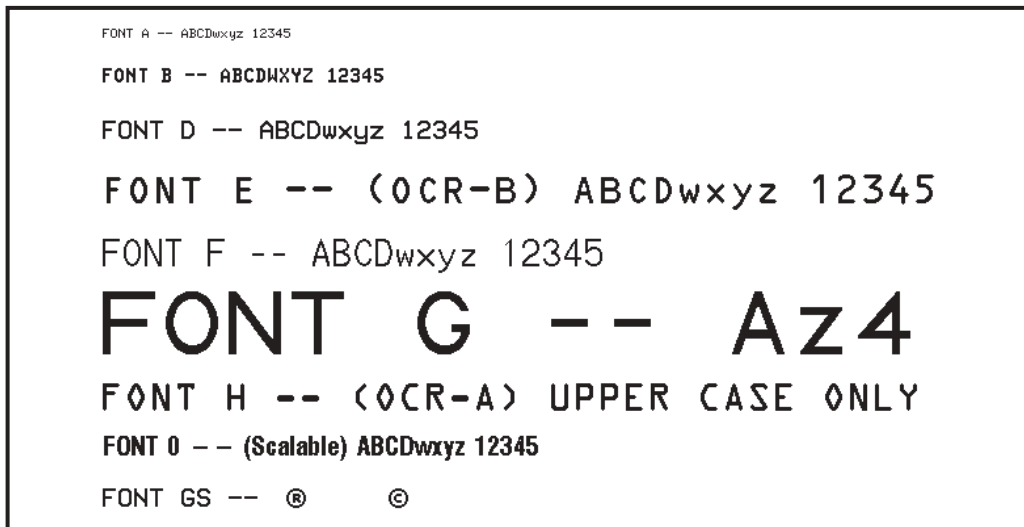

Figure 21. Standard Printer Font Examples

Optional Printer Fonts

There are many optional character fonts that can be purchased for your XiII printer in addition to those which are standard in the unit. From time to time, additions may be made to the list of available fonts. Contact your sales representative for further information.

Only one additional font EPROM can be installed in the printer at a time. This installation should be performed by a service technician. Once installed, this font can be used in addition to the standard fonts available in the printer. Refer to your ZPL II Programming Guide or, if using another software package to drive your printer, to the instructions accompanying that package.

Optional fonts may also be stored on PCMCIA font cards.

Once an optional font is installed in the printer, the Configuration Printout produced during the Cancel Key Self Test will indicate the font type as the "Socket 1 ID".

Figure 22 illustrates the optional fonts and Figure 23 shows sample point sizes for the bitmap smooth fonts.

Table 9. Optional Printer Fonts Currently Available	
Scalable (smooth) Fonts (each is supplied as a complete set of Normal, Bold, Italic, and Bold Italic styles)	Bitmap Fonts (supplied only in Bold). Type sizes: 6, 8, 10, 12, 14, 18, and 24 point.
Arabic	--
Century Schoolbook	--
CG Palacio™	CG Palacio™
CG Times™	CG Times™
CG Triumvirate™	CG Triumvirate™
	CG Triumvirate™ Condensed
Cyrillic	
East European	
Futura™	Futura™
Greek	
Icelandic	
Kanji, Gothic	
Kanji, Mincho	
Kanji, Mincho and Gothic	
Turkish	
Universe®	Universe®

Optional Printer Font Examples.



Figure 22. Select Examples of Optional Fonts

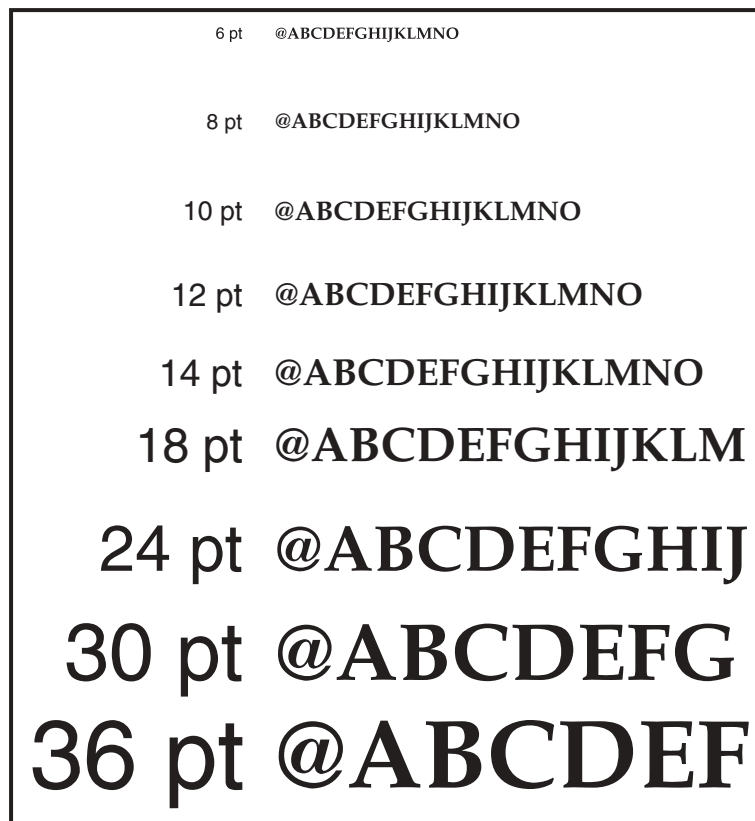

Figure 23. Bitmap Smooth Fonts: Point Size Examples

Appendix

Printer Interface Technical Information

System Considerations

Communications Code

The XiII printer sends and receives American Standard Code for Information Interchange (ASCII). This code consists of 128 characters (256 for Code Page 850) including uppercase and lowercase letters, characters, punctuation marks, and various control codes.

Interfaces

The method of interfacing the Zebra XiII-Series printer to a data source depends on the communication options installed in the printer. The standard interfaces are an RS-232/RS-422/RS-485 serial data port and a bi-directional parallel port. The IBM® Twinax or IBM Coax option is available for those applications which require them.

Data Specifications

When communicating via an asynchronous serial data port (RS-232/RS-422/RS-485), the baud rate, number of data and stop bits, parity, and handshaking are user-selectable. Parity only applies to data transmitted by the XiII printer since the parity of received data is ignored.

When communicating via the parallel port, the previously mentioned parameters are not considered. Refer to “Configuration and Calibration” on page 29 to configure the communication parameters for the XiII printer. The values selected must be the same as those used by the host equipment connected to the XiII printer.

RS-232/RS-422/RS-485 Serial Data Port

The connections for these standard interfaces are made through the DB25S connector on the rear panel. For all RS-232 input and output signals, the XiII printer follows both the Electronics Industries Association's (EIA) RS-232 specifications and the Consultative Committee for International Telegraph and Telephone (CCITT) V.24 standard signal level specifications.

Table 10 shows the pin configuration and function of rear panel serial data connector on the XiII-Series printers.

Table 10. RS-232/RS-422/RS-485 Pinouts	
Pin No.	Description
1	Frame ground for cable shield
2	TXD (RS-232 transmit data) output from printer
3	RXD (RS-232 receive data) input to printer
4	RTS (RS-232 request to send) output from printer
6	DSR (data set ready)input to printer
7	Signal ground for RS-232
9	+5 VDC source output (1 Amp maximum)
11	Signal ground reference for RS-422/RS-485
13	RS-422/RS-485 data input A (-)
14	RS-422/RS-485 data output A (-)
16	RS-422/RS-485 data input B (+)
19	RS-422/RS-485 data output B (+)
20	DTR (RS-232 data terminal ready) output from printer
NOTE: Pins 5, 8, 10, 12, 15, 17-18, 21-25 are not used and are unterminated.	

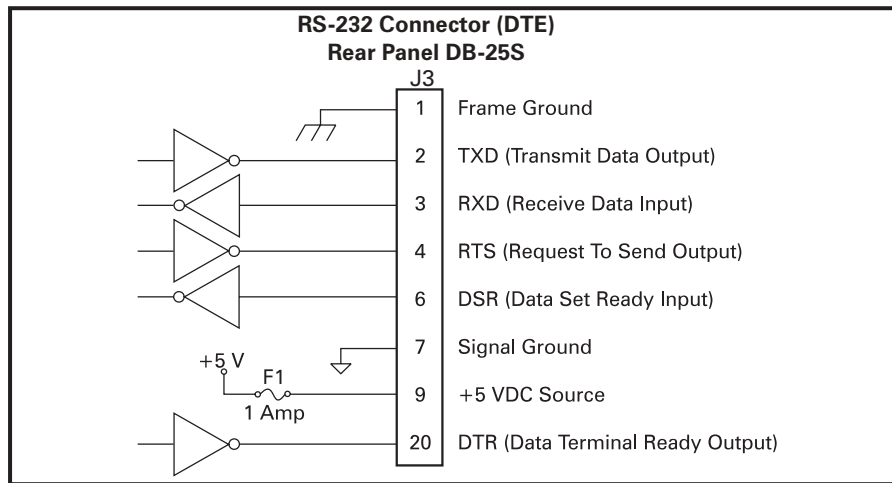

Figure 24. RS-232 Connections

RS-232 Interconnections

The Zebra XiII printer is configured as Data Terminal Equipment (DTE). Figure 24 illustrates the internal connections of the printer's RS-232 connector.

Figure 25 illustrates the connections required to interconnect the XiII printer with the standard 9 pin serial port connector on a PC.

NOTES: If using a 9 pin to 25 pin adapter plug attached to the computer, use a null modem cable between the adapter plug and the Zebra printer.

To connect the printer to other DTE devices with DB-25 connectors (such as the serial port of a PC), an RS-232 null modem (crossover) cable should be used.

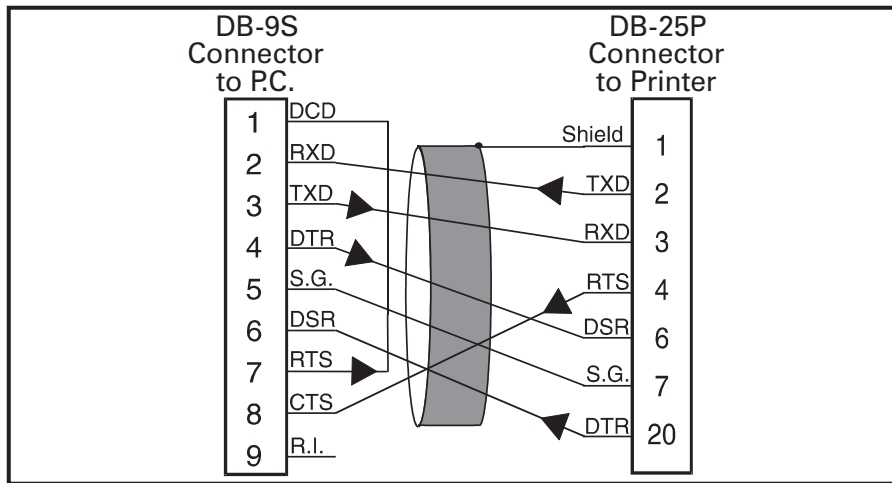

Figure 25. 9 Pin to 25 Pin Interconnecting Cable

When the printer is connected via its RS-232 interface to Data Communication Equipment (DCE) such as a modem, use a standard RS-232 (straight-through) interface cable. Figure 26 illustrates the connections required for this cable.

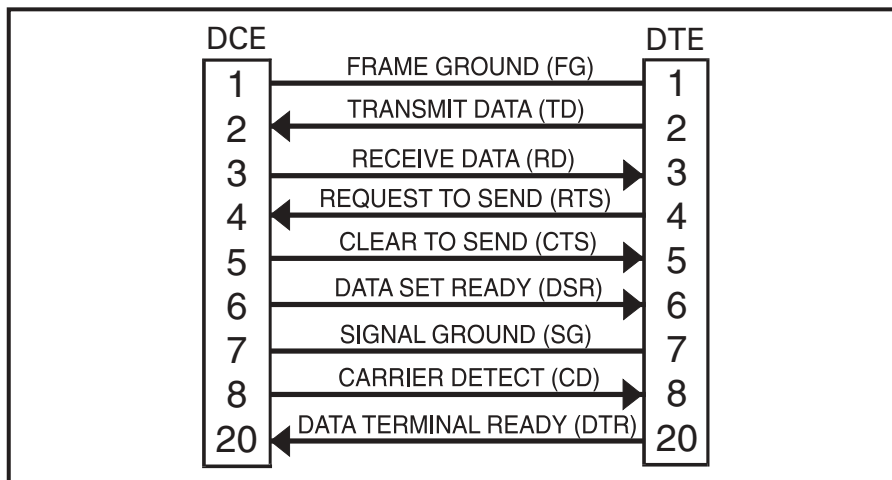

Figure 26. 25 Pin to 25 Pin Interconnecting Cable

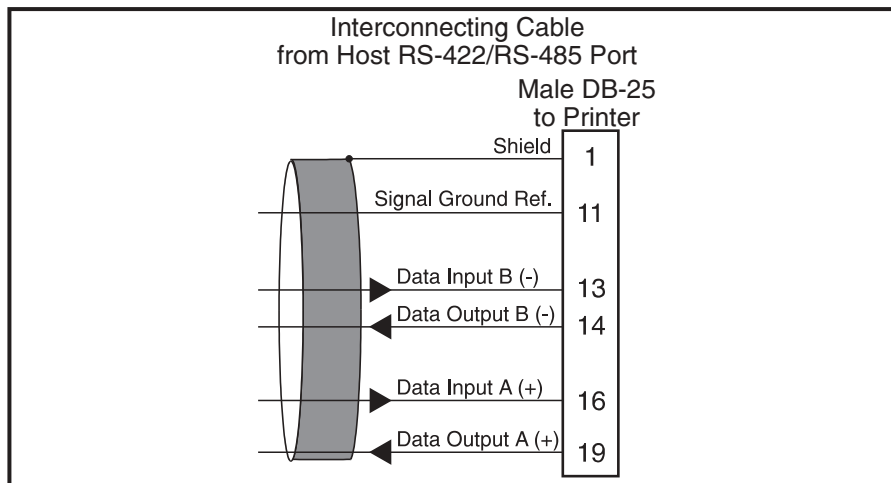

Figure 27. RS-422/RS-485 Interconnecting Cable

RS-422/RS-485 Interconnections

The Zebra XiII printer may be connected to a host by either an RS-422 or an RS-485 interface. The DB-25 connector on the rear of the printer uses specific pins for this purpose. Figure 27 illustrates the required cable wiring for interconnecting to the printer's DB-25 connector. Figure 28 illustrates the internal connections of the XiII printer's RS-422 or RS-485 connector.

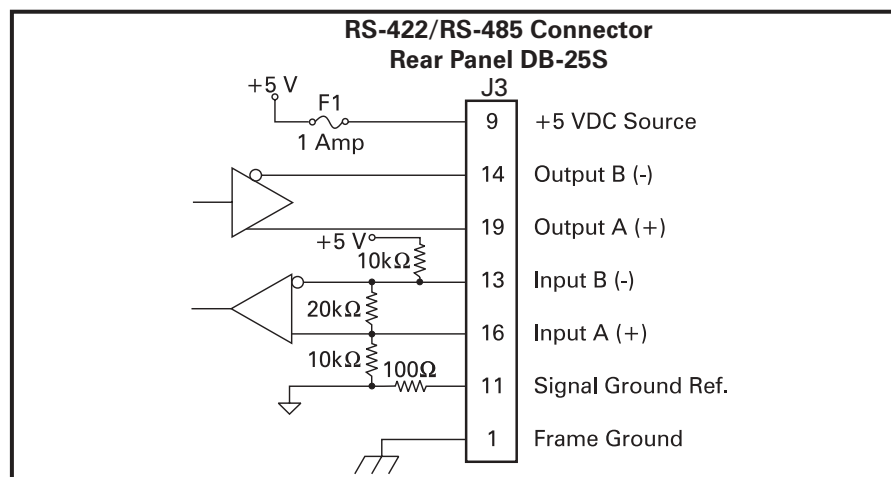

Figure 28. RS-422/RS-485 Connections

Parallel Data Port

A standard 36-pin parallel connector is available at the rear of the printer for connection to the data source. When the printer is properly configured for parallel communications mode, the standard RS-232 port will not function as an input port. The parallel interface receives data from the data source but cannot send back printer status information over this port. However, if the XiII printer receives a “Printer Status Request” command over the parallel interface, it will send back this status over the RS-232 port.

Parallel Port Interconnections

Table 11 shows the pin configuration and function of a standard computer-to-printer parallel cable.

Table 11. Parallel Connector Pinouts	
36-pin Connector	Description
1	The nStrobe printer input has internal 3.3 kW pull-up resistors to 5 V ($I_{OL} = 1.5$ mA) and is designed to receive a signal driven open collector $V_{OL} \leq 0.8$ V. This pin is a signal from the host computer. The nStrobe input is debounced on a LOW going edge to require an active width greater than 0.5 ms before data is latched.
2-9	Data inputs have TTL input characteristics with internal 3.3 kW pullups and represent 1 TTL unit load or less. The Data inputs are positive logic with a HIGH voltage level corresponding to a logic 1. Pin 2 through Pin 9 = D0 through D7 respectively.
10	The nAck output is an active LOW pulse used to indicate termination. nAck is a driven open collector with a 3.3 kW internal pull-up. The output sinks 7 mA to a $V_{OL} \leq 0.4$ V.
11	The Busy output is active HIGH whenever the printer cannot accept data due to any normal or abnormal condition, including buffer overflow, head open, over temperature, and media error conditions. Busy is a driven open collector with a 3.3 kW internal pull-up. The output sinks 7 mA to a $V_{OL} \leq 0.4$ V.
12	The PError signal is active HIGH whenever the printer is out of media or ribbon.
13	The Select signal function is determined by an additional configuration option which becomes active when the port is present. In the default condition, Select is active HIGH whenever the parallel port is powered up and the parallel port is enabled. In the non-default condition, Select will go active LOW whenever the printer is printing.

36-pin Connector	Description
14	nAutoFd (not connected)
15	Not defined
16	Logic Gnd
17	FRAME GROUND is at the same potential as Logic Gnd (pin 16).
18	FUSED 5 V - 1 A maximum.
19-30	SIGNAL GROUNDS are the Logic Grounds and Returns for all input and output signals.
31-35	NOT USED - These leads should be left unconnected.
36	NSelectIn (not connected)

Cabling Requirements

Data cables must be fully shielded and fitted with metal or metalized connector shells. Shielded cables and connectors are required to prevent radiation and reception of electrical noise.

To minimize electrical noise pickup in the cable:

- Keep data cables as short as possible.
- Do not bundle the data cables tightly with the power cords.
- Do not tie the data cables to power wire conduits.

NOTES: Zebra printers comply with FCC “Rules and Regulations”, Part 15, Subpart J, for Class A Equipment, using fully shielded 6-foot data cables. Use of longer cables or unshielded cables may increase radiated emissions above the Class A limits.

RS-422 and RS-485 applications should use twisted shielded pairs as recommended in the Appendix of the TIA/EIA-485 Specification.

ASCII Code Chart

See Table 12. Shaded values are NOT recommended to be used for Command Prefix, Format Prefix, or Delimiter characters.

Table 12. ASCII Code Chart							
HEX	CHAR	HEX	CHAR	HEX	CHAR	HEX	CHAR
00	NUL	20	space	40	@	60	'
01	SOH	21	!	41	A	61	a
02	STX	22	"	42	B	62	b
03	ETX	23	#	43	C	63	c
04	EOT	24	\$	44	D	64	d
05	ENQ	25	%	45	E	65	e
06	ACK	26	&	46	F	66	f
07	BEL	27	'	47	G	67	g
08	BS	28	(48	H	68	h
09	HT	29)	49	I	69	i
0A	LF	2A	*	4A	J	6A	j
0B	VT	2B	+	4B	K	6B	k
0C	FF	2C	,	4C	L	6C	l
0D	CR	2D	-	4D	M	6D	m
0E	SO	2E	.	4E	N	6E	n
0F	SI	2F	/	4F	O	6F	o
10	DLE	30	0	50	P	70	p
11	DC1	31	1	51	Q	71	q
12	DC2	32	2	52	R	72	r
13	DC3	33	3	53	S	73	s
14	DC4	34	4	54	T	74	t
15	NAK	35	5	55	U	75	u
16	SYN	36	6	56	V	76	v
17	ETB	37	7	57	W	77	w
18	CAN	38	8	58	X	78	x
19	EM	39	9	59	Y	79	y
1A	SUB	3A	:	5A	Z	7A	z
1B	ESC	3B	;	5B	[7B	{
1C	FS	3C	<	5C	\	7C	
1D	GS	3D	=	5D]	7D	}
1E	RS	3E	>	5E	^	7E	~
1F	US	3F	?	5F	_	7F	DEL



NOTE: NOT recommended for use as a Command Prefix, Format Prefix, or Delimiter Character

Adjusting Darkness for “In-Spec” Bar Codes

All direct thermal and thermal transfer materials do not use the same darkness setting. The best way to check for the proper darkness is to use a bar code verifier that actually measures bars/spaces and will calculate the PCS (Print Contrast Signal) ratio. Without the assistance of a verifier, your eyes and/or the scanner to be used in the system are the best way to select the optimum darkness setting. What follows is a simple yet effective method for adjusting the darkness to print “in-spec” bar codes.

1. Load media and ribbon (if used), calibrate the printer, and select the proper print method.
2. To print a label for evaluation, use the following procedure:
 - A. With power off, press and hold the Feed key.
 - B. Turn the printer power on, then release the Feed key. The printer will begin printing test labels.
3. Print a label, then press the Pause key. The label will contain two bar codes as well as other printer information. Normal bar codes are printed in a horizontal format as they feed out of the printer. Rotated bar codes are printed in a vertical format.
4. Compare the test label printed to the bar codes in Figure 29. If the test label appears too dark or too light, increase or decrease the darkness setting accordingly.
5. Resume printing by pressing the Pause key again. Print a few labels at the new setting and verify that proper “in-spec” bar codes are being printed. Repeat steps 3, 4, and 5 until satisfied.
6. To terminate the printing of the test labels, press the Pause key, then press the Cancel key.
7. Save the new settings permanently, if desired.

Too Dark

Dark labels are fairly obvious. The normal bar code bars increase in size, and the openings in small alphanumeric characters may fill in with ink. It may be readable but not “in-spec”. Rotated bar code bars and spaces will run together.

Slightly Dark

Slightly dark labels are not as obvious. The normal bar code will be “in-spec”. Small character alphanumerics will be bold and could be slightly filled in. The rotated bar code spaces are small when compared to the in spec code, possibly making the code unreadable.

Slightly Light

Slightly light labels are, in some cases, preferred to slightly dark for “in-spec” bar codes. Both normal and rotated bar codes will be “in-spec”, but small alphanumeric characters may not be complete.

Too Light

Light labels are obvious. Both normal and rotated bar codes have incomplete bars and spaces. Small alphanumeric characters are unreadable.

“In-Spec”

The “in-spec” bar code can only be confirmed by a verifier, but it should exhibit some very visible characteristics. The normal bar code will have complete, even bars and clear, distinct spaces. The rotated bar code will also have complete bars and clear distinct spaces. Although it may not look as good as a slightly dark bar code, it will be “in-spec”. In both normal and rotated styles, small alphanumeric characters will look complete.

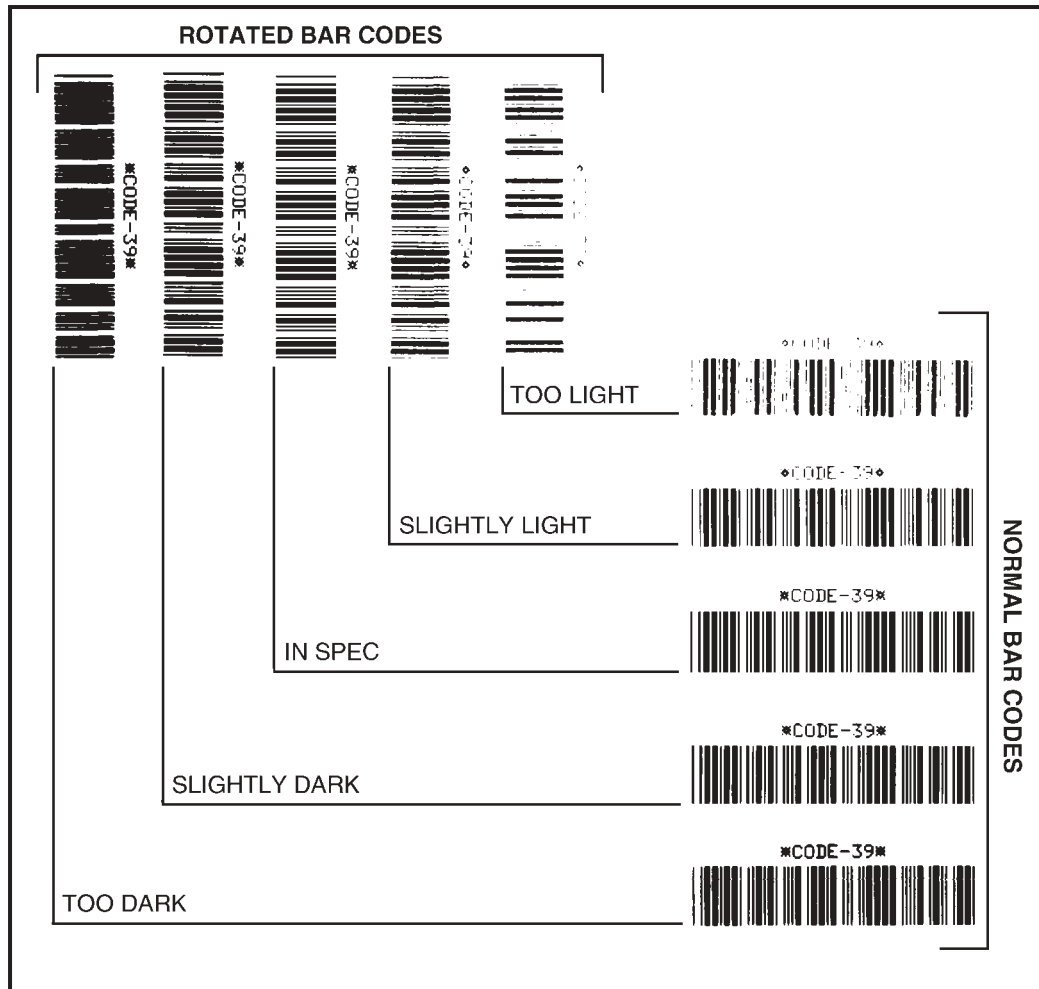

Figure 29. Bar Code Examples



Glossary

alphanumeric Indicating letters, numerals, and characters such as punctuation marks.

backfeed Backfeed is when the printer pulls the media and ribbon (if used) backward into the printer so that the beginning of the label to be printed is properly positioned behind the printhead.

bar code A code by which alphanumeric characters can be represented by a series of adjacent stripes of different widths. Many different code schemes exist, such as the universal product code (UPC) or Code 39.

calibration (of a printer) A process in which the printer determines some basic information needed to print accurately with a particular media/ribbon combination.

character set The set of all letters, numerals, punctuation marks, and other characters that can be expressed by a particular barcode or font.

check digit A character added to a barcode symbol that indicates to the scanner that it has read the symbol correctly.

continuous media Media that has no web (space between labels), notch, or gap to separate each label/tag, but rather the media is one long piece of material. This media is typically cut into labels of similar length.

core diameter The inside diameter of the cardboard core at the center of a roll of media/ribbon.

cutter A device that can cut each label/tag immediately after it is printed.

diagnostics Information about what printer functions are not working. This information is used for troubleshooting problems.

direct thermal printing Printing in which direct thermal media is used. No ribbon is used. Instead, the media is coated with a substance which reacts to heat generated by the printhead to produce an image.

fanfold media Media that comes folded in a rectangular stack, rather than on a roll.

font A complete set of alphanumeric characters in one style of type. Examples: Times, Univers.

ips “inches-per-second” See “print speed.”

label An adhesive-backed piece of paper, plastic, or other material on which information is printed.

label available sensor For printers equipped with the Peel-Off Option, this sensor detects a printed label waiting to be taken or “picked” by the operator. While it detects this label, the printer will not print additional labels. Once the label has been taken, printing resumes. Also called “take-label sensor”.

label backing (label liner) The material on which labels are affixed during manufacture and which is discarded or recycled by the end-users. Label backing (or liner) has a non-stick surface which allows the label to be easily removed by the end-user and placed in the desired location.

media Material onto which data is printed by the printer. Types of media include: tagstock, continuous, fanfold, and roll.

media sensor This sensor is located behind the printhead to detect the presence of media and, for non-continuous media, the position of the web, hole, notch, or mark that separates each label.

media supply hanger The hanger that supports media rolls and provides consistent media feed to the printhead.

non-volatile memory Electronic memory that retains data even when power is removed.

print speed The speed at which printing occurs. For thermal transfer printers, this speed is expressed in terms of ips (inches per second).

printhead wear The degradation of the surface of the printhead and/or the print elements over time. Heat and abrasion can cause printhead wear. Therefore, to maximize the life of your printhead use the lowest print darkness setting (sometimes called burn temperature or head temperature) and

the lowest printhead/toggle pressure necessary. Also, use ribbon that is as wide as or wider than the media to protect the printhead of the XiII printer from the rougher surface of the media.

registration Alignment of printing with respect to the top of a label/tag.

ribbon A band of inked material that is pressed against the media and heated to transfer an image onto the media, which in turn is pressed against the platen. A ribbon consists of a base film coated with wax or resin “ink”. Zebra ribbons also have a back coating that protects the printhead from damage.

ribbon wrinkle A wrinkling of the ribbon caused by improper alignment of the strip plate and/or printhead pressure. This wrinkle can be seen just above the strip plate. Ribbon wrinkle can cause voids in the printing and/or it can cause the spent ribbon to rewind unevenly. Correct this condition by performing adjustment procedures.

roll media Media that comes supplied rolled up on a core (usually cardboard). Contrast this with fanfold media, which comes folded in a rectangular stack.

supplies A general term for ribbon and media.

tag A type of media having no adhesive backing but featuring a hole or notch by which the tag can be hung on something. Usually tags are made of cardboard or other durable material.

take label sensor See “label available sensor”.

thermal direct printing See “direct thermal printing”.

thermal transfer printing A printing method in which the printhead heats an ink- or resin-coated ribbon against the media, causing the ink/resin to transfer onto the media. By selectively heating the ribbon, an image can be formed on the media. See also “ribbon”.

“void” A space where printing should have occurred but, due to some error condition, it did not occur. A void can cause a bar code symbol to be read incorrectly or to not be read at all.



Index

- A**
- AC Power Fuse 54
 - Adjustments
 - Adjusting for “In-Spec” Bar Codes 95
 - Lower Media Sensor 17
 - Media Sensor Position 15
 - Printhead Pressure 57
 - Applicator Interface 73
 - ASCII Code Chart 94
 - Auxiliary Port Setting 43
- B**
- Backfeed Setting 42
 - Baud Rate Setting 38
 - Black Oval keys (2) 25
- C**
- Cables, interconnection
 - 9-to-25 pin 90
 - null modem 89
 - RS-422/RS-485 91
 - Calibrate key 25
 - Calibration
 - Media and Ribbon Sensor 36
 - Cancel key 25
 - Cancel Key Self Test 66
 - Changing Password-Protected Parameters 30
 - Check Ribbon light 26
 - Cleaning
 - Cutter Module 54
 - Exterior 52
 - Interior 52
 - Media Sensors 53
 - Platen Roller 52
 - Printhead 52
 - Cleaning Diagram 53
 - Cleaning Schedule 51
 - Cleaning Solvent 51
 - Communication Parameters, Setting
 - Baud 38
 - Communications Mode 40
 - Data Bits 38
 - Host Handshake 39
 - Host Port 38
 - Network ID 39
 - Parity 38
 - Protocol 39
 - Stop Bits 38
 - Communications Code 87
 - Communications Diagnostics Mode 40
 - Configuration and Calibration 29
 - Configuration Label 66
 - Continuous Media Loading 7
 - Control Prefix Character 40
 - Control Prefix Setting 40
 - Cutter
 - Cleaning 54
 - Cutter Mode 22
- D**
- Darkness setting 32
 - Data light 26
 - Data Specifications 87
 - Defaults, loading factory 31
 - Delimiter Character Setting 41
- E**
- Error light 26
 - Error Messages 59
 - Ethernet Interface 74

F

- Factory defaults 31
- Fanfold Media Loading 10
- Feed key 25
- Feed Key and Pause Key Self Test 68
- Feed Key Self Test 68
- Fonts 83
- Fonts, Optional 85
- Format Prefix Setting 40
- Front Panel Display 2, 24
- Front Panel Keys 25
- Front Panel Lights 26
 - Check Ribbon light 26
 - Data light 26
 - Error light 26
 - Paper Out light 26
 - Pause light 26
 - Power light 26
 - Take Label light 26
- Fuse Replacement 54

G

- Glossary 99

H

- Head Close Setting 41
- Head Resistor Setting 43
- Head Test Count, Setting 43
- Head Test Function 43
- Host Handshake, Setting 39
- Host Port Setting 38

I

- IBM Coax Interface 74
- IBM Twinax Interface 74
- Initial Printer Power-Up 28
- Input and Output Signals
 - CCITT V.24 88
 - EIA RS-232 88
 - Standards Used 88

- In-Spec Bar Codes 95

K

- KMT Printhead 74

L

- Label Available Sensor 22, 27
- Label Positioning, Parameters
 - Backfeed 42
 - Label Top Position 42
 - Left Position 42
- Label Top Position, Adjusting 42
- Left Position Setting 42
- List Bar Codes Setting 34
- List Fonts Setting 34
- List Formats Setting 35
- List Images Setting 35
- List Setup Setting 35
- Listing Printer Information 34
- Loading Media 6
- Loading Ribbon
 - See “Ribbon Loading” 18
- Lower Media Sensor
 - Adjustments 17
 - Figure 17

M

- Maintenance Kit 51
- Maximum Length Setting 34
- Media Loading
 - Continuous Media 7
 - Cutter Mode 11
 - Fanfold 10
 - Fanfold Loading Diagram 10
 - Peel-Off Mode 14
 - Rewind Mode 11
- Media Power-Up Setting 41
- Media Sensor 15, 27
- Media Sensor Assembly
 - Position Adjustment 15
- Media Sensor Calibration 36

- Media Sensor Profile 46
 - Printing 36
- Media Supply Spindle 73
- Media Type Setting 33
- N
- Network ID Setting 39
- Next key 25
- Null modem cable 89
- O
- Operating Modes
 - Cutter Mode 22
 - Peel-Off Mode 22
 - Rewind Mode 22
 - Tear-Off Mode 21
- Operator controls 23
- Options
 - Applicator Interface 73
 - Communication Interfaces 74
 - Cutter 71
 - Ethernet Interface 74
 - Fonts 73, 92
 - IBM Coax Interface 74
 - IBM Twinax Interface 74
 - Internal Fanfold Media Supply Bin 72
 - KMT Printhead 74
 - Media Supply Fins 73
 - Media Supply Spindle 73
 - Memory SIMMs 72
 - On-Line Verifier 72
 - PCMCIA Type I Memory Cards 74
 - Rewind Option 71
 - RS-485 Interface 75
- P
- Paper Out light 26
- Parity, Setting 38
- Pause key 25
- Pause Key Self Test 67
- Pause light 26
- PCMCIA Type I Memory Cards 74
- Peel-Off Mode 22
- Peel-Off Mode Media Loading 14
- POST
 - See “Power-On Self Test” 28
- Power light 26
- Power On/Off Switch 23
- Power-On Self Test 28
- Power-Up and Head Close Parameters 41
- Prefix and Delimiter Characters, Selecting 40
- Preventive Maintenance Kit 51
- Previous key 25
- Print Elements 52
- Print Mode Setting 32
- Print Parameters, Setting
 - Adjusting Print Darkness 32
 - Adjusting Tear-Off Position 32
 - Maximum Length 34
 - Media Type 33
 - Print Method 33
 - Print Mode 32
 - Print Width 34
- Print Width Setting 34
- Printer Connections
 - Parallel Cable 92
 - RS-232 interconnect cable 90
 - RS-422/RS-485 Interconnect Cable 91
 - RS-422/RS-485 Internal Connections 91
- Printer Information, Listing
 - Bar Codes 34
 - Fonts 34
 - Formats 35
 - Images 35
 - Setup 35
- Printer Self Tests
 - Introduction to 65
- Printer Status Sensors 27
 - Label Available Sensor 27
 - Media Sensor 27
 - Printhead Position Sensor 27
 - Printhead Temperature Sensor 27
 - Ribbon Sensor 27

Printhead Pressure Adjustment 57
Printhead Replacement
 Setting the Head Resistor Value 43
Printhead Test 43
Printhead, Cleaning 52
Program Mode, entering 29
Program Mode, leaving 31
Protocol Setting 39

R

Removing the Label Backing Material 15
Removing Used Ribbon 20
Ribbon Loading 18
Ribbon Sensor 27
Ribbon Sensor Calibration 36
Roll Media Loading 9
RS-232 Connections 89
RS-232/RS-422/RS-485 Pinouts 88
RS-422/RS-485 Connections 91
RS-422/RS-485 Interconnection Cable 91
RS-422/RS-485 Internal Connections 91
RS-485 Interface 77

S

Self Tests
 Cancel Key 66
 Communications Diagnostics 68
 Feed Key 68
 Feed Key and Pause Key 68
 Pause Key 67
Sensor Profile, Printing
 See “Media Sensor Profile” 36
Serial Data Port 88
Setup/Exit key 25
Standard Printer Font Examples 84
Stop Bits Setting 38

T

Take Label light 26
Tear-Off Mode 21
Tear-Off Position Setting 32
Tear-Off/Peel-Off Plate 21
Toggle Positioning 56
Troubleshooting
 Error Messages 59

U

Upper Media Sensor 16

W

Warranty Information iii

Z

ZPL Mode Setting 41